

The scaling limit of the energy correlations in non integrable Ising models

Alessandro Giuliani

Università di Roma Tre,

L.go S. L. Murialdo 1, 00146 Roma - Italy

Rafael L. Greenblatt

Università di Roma Tre,

L.go S. L. Murialdo 1, 00146 Roma - Italy

Vieri Mastropietro

Università di Roma Tor Vergata,

V.le della Ricerca Scientifica, 00133 Roma - Italy

April 18, 2012

Dedicated to Elliott Lieb on the occasion of his 80th birthday

Abstract

We obtain an explicit expression for the multipoint energy correlations of a non solvable two-dimensional Ising models with nearest neighbor ferromagnetic interactions plus a weak finite range interaction of strength λ , in a scaling limit in which we send the lattice spacing to zero and the temperature to the critical one. Our analysis is based on an exact mapping of the model into an interacting lattice fermionic theory, which generalizes the one originally used by Schultz, Mattis and Lieb for the nearest neighbor Ising model. The interacting model is then analyzed by a multiscale method first proposed by Pinson and Spencer. If the lattice spacing is finite, then the correlations cannot be computed in closed form: rather, they are expressed in terms of infinite, convergent, power series in λ . In the scaling limit, these infinite expansions radically simplify and reduce to the limiting energy correlations of the integrable Ising model, up to a finite renormalization of the parameters. Explicit bounds on the speed of convergence to the scaling limit are derived.

Contents

1	Introduction	2
1.1	The model and the main results	2
1.2	Ising models, fermionic systems and a comparison with existing literature	10
2	The representation of the interacting Ising model in Grassmann variables	17
2.1	The generating function for the energy correlations	17
2.2	Majorana form of the action	27
2.3	The perturbed scaling limit and the temperature counterterm	33
2.4	Symmetries in the Grassman representation	34
3	Multiscale integration	36
3.1	The integration of the χ field	36
3.2	The iterative integration	42
3.3	Localization and renormalization	43
3.4	Tree expansion for the effective potential	48
	3.4.1 The non-renormalized expansion	52
	3.4.2 The renormalized expansion	53
3.5	The flow of the running coupling constants	55
4	The renormalized correlation functions	58
4.1	The dominant contributions	60
4.2	The subdominant contributions	65

1 Introduction

1.1 The model and the main results

The two-dimensional (2D) Ising model is an oversimplified description of a planar magnet in which the dipoles can point only in two directions and only the interactions among neighboring spins are considered. Remarkably, it can be solved explicitly, as first shown by Onsager [46]: the free energy, the magnetization and several correlation functions in the absence of an external field can be computed in closed form [35, 36, 57, 43].

From a physical point of view, there is no special reason to consider only nearest neighbor (n.n.) interactions: it is natural (and more realistic) to consider generalizations of the n.n. Ising model where the spins interact via

a finite range interaction of the form:

$$H_M = -J \sum_{\mathbf{x} \in a\mathbb{Z}_M^2} \sum_{j=1,2} \sigma_{\mathbf{x}} \sigma_{\mathbf{x}+a\hat{\mathbf{e}}_j} - \lambda \sum_{\{\mathbf{x}, \mathbf{y}\}} \sigma_{\mathbf{x}} v(\mathbf{x} - \mathbf{y}) \sigma_{\mathbf{y}} \equiv H_M^{(0)} + \lambda W_M, \quad (1.1)$$

where J is a positive constant, $\mathbb{Z}_M^2 \subset \mathbb{Z}^2$ is a finite square box of side M with periodic boundary conditions, a is the lattice spacing, $\sigma_{\mathbf{x}} \in \{\pm 1\}$, and $\hat{\mathbf{e}}_j$ are the two unit coordinate vectors on \mathbb{Z}^2 . The sum in the second term of Eq.(1.1) is over all unordered pairs of sites in $\Lambda_L^a := a\mathbb{Z}_M^2$; the interaction potential $v(\mathbf{x} - \mathbf{y})$ is rotation invariant and has finite range, namely: $v(\mathbf{x} - \mathbf{y}) = 0$, $\forall |\mathbf{x}| > R_0 := aM_0$, for a suitable positive integer M_0 . The standard n.n. case corresponds to $\lambda = 0$.

Despite the fact that the models with Hamiltonian $H_M^{(0)}$ or H_M look “physically equivalent”, Onsager’s exact solution is crucially based on the assumption that $\lambda = 0$: therefore, it is natural to ask how much of it survives the presence of the perturbation λW_M .

The thermodynamical properties of the system are obtained by averaging with respect to the Gibbs measure at inverse temperature β : given an observable $F(\underline{\sigma})$ (here $\underline{\sigma} = \{\sigma_{\mathbf{x}}\}_{\mathbf{x} \in \Lambda_L^a}$), its statistical average is defined as

$$\langle F \rangle_{\beta, L} = \frac{\sum_{\underline{\sigma} \in \Omega_M} e^{-\beta H_M(\underline{\sigma})} F(\underline{\sigma})}{\sum_{\underline{\sigma} \in \Omega_M} e^{-\beta H_M(\underline{\sigma})}} \quad (1.2)$$

where $\Omega_M = \{\pm 1\}^{\Lambda_L^a}$ is the spin configuration space. In particular, the averages $\langle \sigma_{\mathbf{x}_1} \cdots \sigma_{\mathbf{x}_n} \rangle_{\beta, L}$ are the multipoint spin correlation functions. Taking $L \rightarrow \infty$ at $\{\mathbf{x}_1, \dots, \mathbf{x}_n\}$ fixed produces the infinite volume correlation functions:

$$\langle \sigma_{\mathbf{x}_1} \cdots \sigma_{\mathbf{x}_n} \rangle_{\beta} = \lim_{L \rightarrow \infty} \langle \sigma_{\mathbf{x}_1} \cdots \sigma_{\mathbf{x}_n} \rangle_{\beta, L} \quad (1.3)$$

the collection of which characterizes the infinite volume Gibbs state. Two key thermodynamic quantities are the free energy and the specific heat, defined as follows: the free energy per site in the thermodynamic limit is

$$f_{\beta} = - \lim_{M \rightarrow \infty} \frac{1}{\beta M^2} \log Z, \quad (1.4)$$

where $Z = \sum_{\underline{\sigma} \in \Omega_M} \exp\{-\beta H_M(\underline{\sigma})\}$ is the partition function. The specific heat is $C_v = -\beta^2 \frac{\partial^2 (\beta f_{\beta})}{\partial \beta^2}$, and can be obtained by summing over the energy density correlation functions: if we define the energy density operator as $\varepsilon_{\mathbf{x}, j} := a^{-1} \sigma_{\mathbf{x}} \sigma_{\mathbf{x}+a\hat{\mathbf{e}}_j}$, then

$$C_v = (\beta J)^2 \lim_{L \rightarrow \infty} \frac{1}{L^2} \sum_{j, j'} \int_{\Lambda_L^a \times \Lambda_L^a} d\mathbf{x} d\mathbf{y} \langle \varepsilon_{\mathbf{x}, j}; \varepsilon_{\mathbf{y}, j'} \rangle_{\beta, L}^T, \quad (1.5)$$

where $\int_{\Lambda_L^a} d\mathbf{x}$ is a shorthand for $a^2 \sum_{\mathbf{x} \in \Lambda_L^a}$ and $\langle \cdot; \cdot \rangle_{\beta, L}^T$ indicates the truncated expectation: $\langle \varepsilon_{\mathbf{x}, j}; \varepsilon_{\mathbf{y}, j'} \rangle_{\beta, L}^T = \langle \varepsilon_{\mathbf{x}, j} \varepsilon_{\mathbf{y}, j'} \rangle_{\beta, L} - \langle \varepsilon_{\mathbf{x}, j_1} \rangle_{\beta, L} \langle \varepsilon_{\mathbf{y}, j_2} \rangle_{\beta, L}$. Note that the thermodynamic functions like the free energy and the specific heat are *independent* of the lattice spacing a while the correlation functions explicitly (if straightforwardly) depend on it.

If $\lambda = 0$, Onsager's exact solution shows that the free energy is analytic for $\beta \neq \beta_c$, where $\beta_c = J^{-1} \tanh^{-1}(\sqrt{2} - 1)$ is the inverse critical temperature. For $\beta < \beta_c$ there is a unique infinite volume Gibbs state (the ‘‘high temperature state’’) with zero spontaneous magnetization (i.e. $\langle \sigma_{\mathbf{x}} \rangle_{\beta} = 0$) and characterized by exponential decay of the multipoint spin correlations as the separation between spins is sent to infinity. For $\beta > \beta_c$ there are exactly two pure Gibbs states $\langle \cdot \rangle_{\beta}^{\pm}$, which generate all possible infinite volume Gibbs states by convex combinations [1, 30] (the ‘‘low temperature states’’): they have a non zero spontaneous magnetization (i.e. $\langle \sigma_{\mathbf{x}} \rangle_{\beta}^{\pm} = \pm m^*(\beta) \neq 0$) and are characterized by exponential decay of the multipoint *truncated* spin correlations as the separation between spins is sent to infinity. At the critical point, the rate of the exponential decay goes to zero proportionally to $|\beta - \beta_c|$ and the correlation functions decay polynomially to zero, with specific *critical exponents*; e.g., the spin-spin as $\langle \sigma_{\mathbf{x}} \sigma_{\mathbf{y}} \rangle \sim (\text{const.}) |\mathbf{x} - \mathbf{y}|^{-1/4}$, while the energy-energy correlation decays as $\langle \varepsilon_{\mathbf{x}, j} \varepsilon_{\mathbf{y}, j'} \rangle \sim (\text{const.}) |\mathbf{x} - \mathbf{y}|^{-2}$, asymptotically as $|\mathbf{x} - \mathbf{y}| \rightarrow \infty$. Correspondingly, the specific heat diverges logarithmically $C_v \sim (\text{const.}) \log |\beta - \beta_c|$ at the critical point. We remark that, even after having understood the integrability structure of the model, underlying the Onsager's computation of the free energy, the determination of the spin-spin critical exponent is very involved: $\langle \sigma_{\mathbf{x}} \sigma_{\mathbf{0}} \rangle_{\beta}$ is expressed as a determinant of a large matrix, of size increasing with the distance between spins, whose asymptotic behavior along special directions can be obtained via the use of Szegő's lemma [43] or via the use of the analyticity structure of a set of exact quadratic difference equations that $\langle \sigma_{\mathbf{x}} \sigma_{\mathbf{0}} \rangle_{\beta}$ satisfies exactly at the lattice level [44].

On the other hand, the computation of the multipoint energy correlations at $\lambda = 0$ is a relatively simple matter. Defining the truncated energy correlations as

$$\langle \varepsilon_{\mathbf{x}_1, j_1}; \dots; \varepsilon_{\mathbf{x}_m, j_m} \rangle_{\beta, L}^T = a^{-2n} \frac{\partial^n}{\partial A_{\mathbf{x}_1, j_1} \dots \partial A_{\mathbf{x}_n, j_n}} \log Z(\mathbf{A}) \Big|_{\mathbf{A}=\mathbf{0}}, \quad (1.6)$$

with

$$Z(\mathbf{A}) = \sum_{\underline{\sigma} \in \Omega_M} \exp\{-\beta H_M(\underline{\sigma}) + \sum_{j=1}^2 \int_{\Lambda_L^a} \varepsilon_{\mathbf{x}, j} A_{\mathbf{x}, j}\}, \quad (1.7)$$

it turns out that at $\lambda = 0$ the correlations $\langle \varepsilon_{\mathbf{x}_1, j_1}; \dots; \varepsilon_{\mathbf{x}_m, j_m} \rangle_{\beta, L}^T$ can be

written in closed form for all finite a, L . Their expression further simplifies in the thermodynamic limit $L \rightarrow \infty$ and in a scaling limit in which a and $\beta - \beta_c$ are simultaneously sent to zero: defining $t_c = \tanh \beta_c J = \sqrt{2} - 1$, $t = \tanh \beta(a)J$ and fixing $\beta(a)$ in such a way that

$$\frac{t - t_c}{t_c} = \frac{a\sigma(a)}{2},$$

with $\sigma(a) \neq 0$ for $a \neq 0$ and $\lim_{a \rightarrow 0} \sigma(a) = m^* \in \mathbb{R}$, then, for all the m -tuples of non-coinciding points $\mathbf{x}_1, \dots, \mathbf{x}_m \in \mathbb{R}^2$, $m \geq 2$, $\mathbf{x}_i \neq \mathbf{x}_j \forall i \neq j$,

$$\begin{aligned} & \lim_{a \rightarrow 0} \lim_{L \rightarrow \infty} \langle \varepsilon_{\mathbf{x}_1, j_1}; \dots; \varepsilon_{\mathbf{x}_m, j_m} \rangle_{\beta(a), L}^T \Big|_{\lambda=0} = & (1.8) \\ & = -\frac{1}{2m} \left(\frac{i}{\pi}\right)^m \sum_{\pi \in \Pi_{\{1, \dots, m\}}} \sum_{\omega_1, \dots, \omega_m} \left[\prod_{k=1}^m \omega_k \mathbf{g}_{\omega_k, -\omega_{k+1}}^0(\mathbf{x}_{\pi(k)} - \mathbf{x}_{\pi(k+1)}) \right] \end{aligned}$$

where: (1) $j_k \in \{1, 2\}$ and the limit is independent of the choice of these labels; (2) $\Pi_{\{1, \dots, n\}}$ is the set of permutations over $\{1, \dots, n\}$, with $\pi(n+1)$ interpreted as equal to $\pi(1)$, and $\omega_k \in \{\pm\}$, with ω_{n+1} interpreted as equal to ω_1 ; (3) $\mathbf{g}^0(\mathbf{x})$ is given by

$$\mathbf{g}^0(\mathbf{x}) = \int \frac{d\mathbf{k}}{2\pi} \frac{e^{-i\mathbf{k}\mathbf{x}}}{\mathbf{k}^2 + (m^*)^2} \begin{pmatrix} ik_1 + k_2 & im^* \\ -im^* & ik_1 - k_2 \end{pmatrix}, \quad (1.9)$$

which is a well known object in Quantum Field Theory (QFT): it verifies the *Dirac equation* in 1 + 1 dimensions, which describes a quantum relativistic fermion

$$\begin{pmatrix} \partial_1 + i\partial_2 & im^* \\ -im^* & \partial_1 - i\partial_2 \end{pmatrix} \mathbf{g}^0(\mathbf{x}) = 0 \quad (1.10)$$

The derivation of Eq.(1.8) will be reviewed below. It is based on a correspondence between the energy operator of the Ising model at the site \mathbf{x} and the mass operator $(i/\pi)\psi_{\mathbf{x},+}\psi_{\mathbf{x},-}$ of a QFT of *non-interacting Majorana fermions*, with propagator $\mathbb{E}(\psi_{\mathbf{x},\omega}\psi_{\mathbf{y},\omega'}) = \mathbf{g}_{\omega,\omega'}^0(\mathbf{x} - \mathbf{y})$. The r.h.s. of Eq.(1.8) can be recognized as the multipoint truncated fermionic correlation $(i/\pi)^m \mathbb{E}^T(\psi_{\mathbf{x}_1,+}\psi_{\mathbf{x}_1,-}; \dots; \psi_{\mathbf{x}_m,+}\psi_{\mathbf{x}_m,-})$, where \mathbb{E}^T is computed via the fermionic Wick rule and is given by the sum over the pairings (“contractions”) of the ψ fields; each pairing is equal to the product of the propagators associated with all the contracted pairs, times the sign of the permutation needed to bring the contracted fermionic fields next to each other. The outcome can be naturally represented in terms of Feynman diagrams and truncation means that only connected diagrams are considered; in graphical terms, the r.h.s. of Eq.(1.8) can be thought of as a sum over simple *loop graphs*, see Fig.1.

$$\langle \varepsilon_{\mathbf{x}_1, j_1}; \dots; \varepsilon_{\mathbf{x}_m, j_m} \rangle_{\beta(a), L}^T \Big|_{\lambda=0} \rightarrow \text{Diagram} + \text{permutations}$$

Figure 1: Graphical representation of Eq.(1.22) in the case $m = 6$. The wavy lines represent the external fields $A_{\mathbf{x}, j}$, which can be thought of as being associated to the vertices. These are labeled by the space coordinate \mathbf{x} of the pair of fields $\psi_{\mathbf{x},+} \psi_{\mathbf{x},-}$ “exiting from the vertex”. The fields are contracted two by two: the result of the contraction is represented by a solid line (labeled by the ω, ω' indices of the two contracted ψ fields) and is associated with a propagator \mathbf{g}^0 .

Note that the thermodynamic limit $L \rightarrow \infty$ is performed at $\beta = \beta(a) \neq \beta_c$; after the thermodynamic limit $\beta(a)$ is sent to β_c and, depending on the speed at which $\beta(a) \rightarrow \beta_c$, the resulting expression has a different *effective mass* m^* , which is a finite real number. In particular, in the special case $m^* = 0$, the propagator reduces to

$$\mathbf{g}_{\omega\omega'}^0(\mathbf{x}) \Big|_{m^*=0} = \frac{\delta_{\omega,\omega'}}{x_1 + i\omega x_2}. \quad (1.11)$$

In the literature, the explicit expression Eq.(1.8) with $m^* = 0$ is usually referred to as the *critical* multipoint energy correlation *in the plane*, see e.g. [16]; the result is independent of the specific boundary conditions imposed on Λ_L^a . On the contrary, if the lattice spacing a is sent to 0 directly at $\beta = \beta_c$, with L kept fixed, then one gets a different expression, which is sensitive to the specific boundary conditions imposed on Λ_L^a : e.g. if periodic boundary conditions are considered, the multipoint energy correlations tend to the so-called *critical correlations on the torus* [16].

All these results rely on the exact solution of the n.n. Ising model. As mentioned above, an exact expression for the energy correlations is known also at finite a and has a form similar to Eq.(1.8), still expressed in terms of loop graphs but with a different (and more involved) lattice propagator; in the scaling limit, it simplifies and reduces to the nice expression Eq.(1.8), formally coinciding with the correlations of non interacting Majorana fermions. When $\lambda \neq 0$, the situation is radically different; there is *no exact solution* in that case, and in particular no explicit expression for the m -point energy correlations is known. If the temperature is well inside the high or low tem-

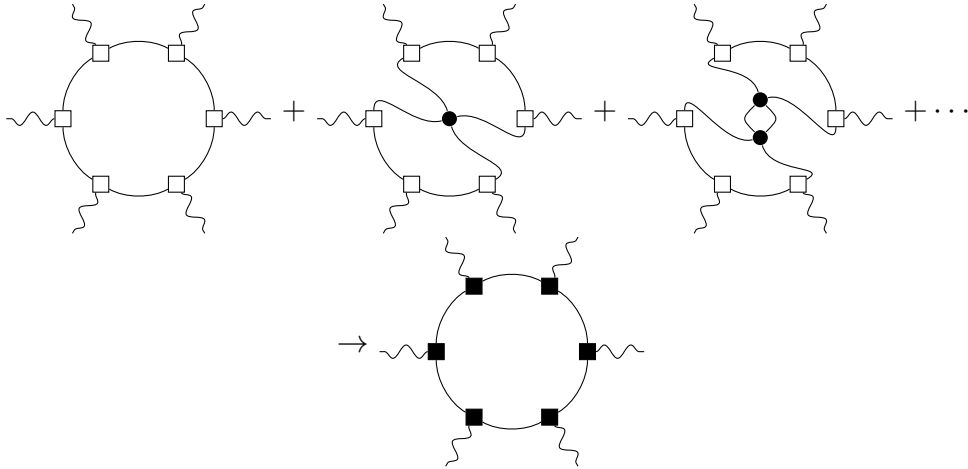

Figure 2: Schematic summary of the renormalization of the correlation functions in the scaling limit. The symbol \blacksquare denotes a dressed vertex, proportional to a renormalization factor $\bar{Z}(\lambda)$.

perature phase, one can pursue a perturbative approach based on cluster expansion methods, which allows one to prove quantitatively that the behavior of the perturbed system is close to the exactly solvable one, see e.g. [45, 49, 23]. The difficult and subtle case is when the system is close to or at the critical point. In this case, the cluster expansion argument breaks down: the perturbation theory is affected by infrared divergences related to the slow decay of correlations, which may a priori change the critical exponents and the nature of the critical point. Spencer [54] and Pinson and Spencer [47] introduced a new point of view using a generalization of the mapping between 2D Ising models and fermionic systems, first discovered by Schultz, Mattis and Lieb [52]. While the n.n. Ising model is equivalent to a system of non-interacting fermions, when $\lambda \neq 0$ the equivalence is with a system of *interacting fermions*. By such mapping (which is reproduced and extended to more general interactions than those in [47] in Section 2 below) one immediately gets a perturbative expansion for the energy correlations in terms of Feynman graphs of arbitrary order, see the first line of Fig.2; contrary to the $\lambda = 0$ case, now graphs with any number of loops appear.

The aim of this paper is to control and compute the scaling limit of these energy correlations: this means to control and compute the ground state correlations of the underlying interacting fermionic theory, uniformly in the effective mass m^* . We show that the apparent infrared divergences at $m^* = 0$ can be resummed by rigorous Renormalization Group methods: the outcome

is a *renormalized expansion* for the m -point energy correlations that is convergent for λ small enough, as shown in [47] for the 2-point function. On top of it, and in addition to the estimates derived in [47], we compute the *explicit exact expression* of the interacting multipoint energy correlations in the scaling limit and show that they coincide with an expression completely analogous to the one obtained for the integrable Ising model, up to a finite renormalization of the parameters. Graphically, the sum over infinite Feynman diagrams with an arbitrary number of loops in the first line of Fig.2 can be shown to be *equal* to a sum over simple *dressed* loop diagrams, like the one in the second line of Fig.2, up to subdominant corrections that vanish in the scaling limit. We stress that the use of fermionic methods is crucial to establish these results, which remained open problems for several years and appeared out of reach in terms of the original spin variables. Our main result is summarized in the following theorem.

Theorem 1.1. *There exists $\lambda_0 > 0$ such that if $|\lambda| \leq \lambda_0$ the following is true. There exists an analytic function of λ , called $\beta_c(\lambda)$, which is the critical temperature of the Ising model Eq.(1.1). Defining $t_c(\lambda) = \tanh \beta_c(\lambda)J$, $t = \tanh \beta(a)J$ and fixing $\beta(a)$ in such a way that*

$$\frac{t - t_c(\lambda)}{t_c(\lambda)} = \frac{t_c(\lambda)}{t_c(0)} \frac{a\sigma(a)}{2},$$

with $\sigma(a) \neq 0$ for $a \neq 0$ and $\lim_{a \rightarrow 0} \sigma(a) = m^* \in \mathbb{R}$, then, for all the m -tuples of non-coinciding points $\mathbf{x}_1, \dots, \mathbf{x}_m \in \mathbb{R}^2$, $m \geq 2$, $\mathbf{x}_i \neq \mathbf{x}_j \forall i \neq j$,

$$\begin{aligned} & \lim_{a \rightarrow 0} \lim_{L \rightarrow \infty} \langle \varepsilon_{\mathbf{x}_1, j_1}; \dots; \varepsilon_{\mathbf{x}_m, j_m} \rangle_{\beta(a), L}^T = \\ & = -\frac{1}{2m} \left(\frac{i}{\pi} \right)^m \sum_{\pi \in \Pi_{\{1, \dots, m\}}} \sum_{\omega_1, \dots, \omega_m} \left[\prod_{k=1}^m \omega_k \mathbf{g}_{\omega_k, -\omega_{k+1}}(\mathbf{x}_{\pi(k)} - \mathbf{x}_{\pi(k+1)}) \right] \end{aligned} \quad (1.12)$$

where: (1) $j_i \in \{1, 2\}$ and the limit is independent of the choice of these labels; (2) $\Pi_{\{1, \dots, n\}}$ is the set of permutations over $\{1, \dots, n\}$, with $\pi(n+1)$ interpreted as equal to $\pi(1)$, and $\omega_k \in \{\pm\}$, with ω_{n+1} interpreted as equal to ω_1 ; (3) the dressed propagator in the scaling limit is

$$\mathbf{g}(\mathbf{x}) = \bar{Z}(\lambda) \int \frac{d\mathbf{k}}{2\pi} \frac{e^{-i\mathbf{k}\mathbf{x}}}{\mathbf{k}^2 + [Z^*(\lambda)m^*]^2} \begin{pmatrix} ik_1 + k_2 & iZ^*(\lambda)m^* \\ -iZ^*(\lambda)m^* & ik_1 - k_2 \end{pmatrix}, \quad (1.13)$$

where the renormalizations $\bar{Z}(\lambda), Z^*(\lambda) \in \mathbb{R}$ are analytic functions of λ , analytically close to 1.

Therefore, even in presence of an interaction, the continuum limit of the energy operator can still be identified with the mass operator of a *free* fermion, up to a finite renormalization of the mass and of the wave function. Note that the case $m^* = 0$ is included in the theorem. The critical temperature is renormalized by the interaction, too; on the contrary, the energy critical exponents are protected against renormalization. The theorem is proved by combining the methods of Pinson and Spencer [47, 54] with the analysis of the massive Thirring model developed by Benfatto, Falco and Mastropietro [8]. The proof of the existence of the scaling limit behind Theorem 1.1 also allows us to fully control how fast the scaling limit of the energy correlations is reached, as stated explicitly in the next theorem.

Theorem 1.2. *Given $\lambda, \beta(a)$ and $\mathbf{x}_1, \dots, \mathbf{x}_m$ as in the statement of Theorem 1.1, defining*

$$\mathbf{g}^{(a)}(\mathbf{x}) = \bar{Z}(\lambda) \int_{[-\frac{\pi}{a}, \frac{\pi}{a}]^2} \frac{d\mathbf{k}}{2\pi} \frac{e^{-i\mathbf{k}\mathbf{x}}}{|D_a(\mathbf{k})|^2 + [Z^*(\lambda)\sigma(a)]^2} \begin{pmatrix} D_a^+(\mathbf{k}) & iZ^*(\lambda)\sigma(a) \\ -iZ^*(\lambda)\sigma(a) & D_a^-(\mathbf{k}) \end{pmatrix} \quad (1.14)$$

we have:

$$\begin{aligned} \lim_{L \rightarrow \infty} \langle \varepsilon_{\mathbf{x}_1, j_1}; \dots; \varepsilon_{\mathbf{x}_m, j_m} \rangle_{\beta(a), L}^T &= \\ &= -\frac{1}{2m} \left(\frac{i}{\pi}\right)^m \sum_{\pi \in \Pi_{\{1, \dots, m\}}} \sum_{\omega_1, \dots, \omega_m} \left[\prod_{k=1}^m \omega_k \mathbf{g}_{\omega_k, -\omega_{k+1}}^{(a)}(\mathbf{x}_{\pi(k)} - \mathbf{x}_{\pi(k+1)}) \right] + \\ &+ R^{(a)}(\mathbf{x}_1, j_1; \dots; \mathbf{x}_m, j_m), \end{aligned} \quad (1.15)$$

where, denoting by $D_{\underline{\mathbf{x}}}$ the diameter of $\underline{\mathbf{x}} = \{\mathbf{x}_1, \dots, \mathbf{x}_m\}$ and by $\delta_{\underline{\mathbf{x}}}$ the minimal distance among the points in $\underline{\mathbf{x}}$, for all $\theta \in (0, 1)$ and $\varepsilon \in (0, 1/2)$ and a suitable $C_{\theta, \varepsilon} > 0$, the correction term $R^{(a)}$ can be bounded as

$$|R^{(a)}(\mathbf{x}_1, j_1; \dots; \mathbf{x}_m, j_m)| \leq C_{\theta, \varepsilon}^m m! \frac{1}{\delta_{\underline{\mathbf{x}}}^m} \left(\frac{a}{\delta_{\underline{\mathbf{x}}}}\right)^\theta \left(\frac{\delta_{\underline{\mathbf{x}}}}{D_{\underline{\mathbf{x}}}}\right)^{2-2\varepsilon}. \quad (1.16)$$

Note that the contributions in the second line of Eq.(1.15) tend to Eq.(1.12) in the limit as $a \rightarrow 0$, in a way controlled by the difference $\|\mathbf{g}^{(a)}(\mathbf{x}) - \mathbf{g}(\mathbf{x})\|$, which is bounded by $|\mathbf{x}|^{-1} e^{-(\text{const.})m^*|\mathbf{x}|} (a|\mathbf{x}|^{-1} + |\sigma(a) - m^*| \cdot |\mathbf{x}|)$ as $a \rightarrow 0$ and $\sigma(a) \rightarrow m^*$. Note also that the combinatorial factor $m!$ in the r.h.s. of Eq.(1.16) is the optimal one and corresponds to the same combinatorial growth as $m \rightarrow \infty$ as the dominant term in the second line of Eq.(1.15).

Moreover, let us remark that the proof of Theorem 1.2 tells more than what is stated above. In particular, it allows us to distinguish, among the

contributions to $R^{(a)}$, the terms of order 1 in λ from those of order at least λ ; the former are very explicit and can be put in a form similar to (even though a bit more cumbersome than) the second line of Eq.(1.15); if we isolated them from $R^{(a)}$, then the remaining contributions to $R^{(a)}$ would be bounded by the r.h.s. of Eq.(1.16) times $|\lambda|$. Finally, in the massive case, $m^* \neq 0$, Eq.(1.16) can obviously be improved, by taking into account the exponential decay of the propagators on distances larger than $(m^*)^{-1}$. In this respect, the bound Eq.(1.16) is stated with the massless case in mind, this being the most difficult to treat.

1.2 Ising models, fermionic systems and a comparison with existing literature

In order to put our results in the right context and clarify the relation between spin and fermionic systems, we recall here some basic facts about the Ising model and its generalizations. Of course the literature on the Ising model is immense and we will give here only a partial view on the aspects more related to our work, pointing out the connections with the more recent literature and the main open problems.

Let us start by discussing the relation between the *integrable* Ising model and fermionic systems. Schultz, Mattis and Lieb [52] derived the exact solution of the n.n. Ising model by a method alternative to the Onsager's one: they showed that the transfer matrix can be written as the exponential of a quantum Hamiltonian describing *non interacting* fermions on a one-dimensional lattice, and they computed its trace by using second quantization methods. The Schultz-Mattis-Lieb solution points out a connection between two apparently unrelated systems, namely 2D classical spin systems and quantum many body 1D non relativistic fermions. The relation between the *critical* Ising theory and a *relativistic* fermionic QFT can then be realized in several ways. One is to start from the Schultz-Mattis-Lieb representation, as in [32, 51], and then use the fact, discovered by Tomonaga [55], that a many body system of non relativistic fermions in $d = 1$ can be effectively described in terms of relativistic fermions in $1 + 1$ dimensions. Another possibility is to start from the Grassmann integral representation of the Ising model partition function, as proposed by Hurst and Green [31] and Samuel [50], see also Itzykson-Drouffe [32]. This approach starts from the observation, see [43], that the generating function of the n.n. Ising model with periodic boundary conditions can be written in terms of four Pfaffians, each of which can be represented as a suitable Grassmann integral. Recalling the

definition of $Z(\mathbf{A})$, Eq.(1.7), the outcome is (see e.g. [27, 50])

$$Z^0(\mathbf{A}) := Z(\mathbf{A}) \Big|_{\lambda=0} = \frac{1}{2} \sum_{\alpha \in \{\pm\}^2} \tau_\alpha Z_\alpha^0(\mathbf{A}), \quad (1.17)$$

with $\tau_{+,-} = \tau_{-,+} = \tau_{-,-} = -\tau_{+,+} = 1$ and

$$\begin{aligned} Z_\alpha^0(\mathbf{A}) &= (-2a^{-2})^{M^2} \left[\prod_{\mathbf{x} \in \Lambda_L^\alpha} \prod_{j=1}^2 \cosh(\beta J + aA_{\mathbf{x},j}) \right] \int \mathcal{D}\Phi e^{S(\Phi, \mathbf{A})}, \\ S(\Phi, \mathbf{A}) &= a \sum_{\mathbf{x} \in \Lambda_L^\alpha} \left[\sum_{j=1}^2 \tanh(\beta J + aA_{\mathbf{x},j}) E_{\mathbf{x},j} + \right. \\ &\quad \left. + \bar{H}_\mathbf{x} H_\mathbf{x} + \bar{V}_\mathbf{x} V_\mathbf{x} + \bar{V}_\mathbf{x} \bar{H}_\mathbf{x} + V_\mathbf{x} \bar{H}_\mathbf{x} + H_\mathbf{x} \bar{V}_\mathbf{x} + V_\mathbf{x} H_\mathbf{x} \right]. \end{aligned} \quad (1.18)$$

Here $\bar{H}_\mathbf{x}, H_\mathbf{x}, \bar{V}_\mathbf{x}, V_\mathbf{x}$ are independent *Grassmann variables* (see e.g. [25] for the basic properties of Grassmann variables and integration), four for each lattice site, and $E_{\mathbf{x},1} = \bar{H}_\mathbf{x} H_{\mathbf{x}+a\hat{e}_1}$, while $E_{\mathbf{x},2} = \bar{V}_\mathbf{x} V_{\mathbf{x}+a\hat{e}_2}$. Moreover, $\Phi = \{\bar{H}_\mathbf{x}, H_\mathbf{x}, \bar{V}_\mathbf{x}, V_\mathbf{x}\}_{\mathbf{x} \in \Lambda_M^\alpha}$ denotes the collection of all of these Grassmann symbols and $\mathcal{D}\Phi$ is a shorthand for $\prod_{\mathbf{x}} d\bar{H}_\mathbf{x} dH_\mathbf{x} d\bar{V}_\mathbf{x} dV_\mathbf{x}$. The label $\alpha = (\alpha_1, \alpha_2)$, with $\alpha_1, \alpha_2 \in \{\pm\}$, refers to the boundary conditions, which are periodic or antiperiodic in the horizontal (resp. vertical) direction, depending on whether α_1 (resp. α_2) is equal to + or -:

$$\begin{aligned} \bar{H}_{\mathbf{x}+L\hat{e}_i} &= \alpha_i \bar{H}_\mathbf{x}, & H_{\mathbf{x}+L\hat{e}_i} &= \alpha_i H_\mathbf{x}, \\ \bar{V}_{\mathbf{x}+L\hat{e}_i} &= \alpha_i \bar{V}_\mathbf{x}, & V_{\mathbf{x}+L\hat{e}_i} &= \alpha_i V_\mathbf{x}. \end{aligned} \quad (1.19)$$

These boundary conditions may be important or not in the thermodynamic limit, depending on whether we are at or outside the critical point. If $\beta \neq \beta_c$, then $|Z_\alpha^0(\mathbf{0})/Z_{-,-}^0(\mathbf{0})|$ converges exponentially to 1 as $L \rightarrow \infty$, see [41, Appendix G]; moreover, if $\beta > \beta_c$, then $Z_\alpha^0(\mathbf{0})$ is positive as $L \rightarrow \infty$ for all α , while if $\beta < \beta_c$, then $Z_{+,+}^0(\mathbf{0})$ is definitely positive and the other partition functions with different boundary conditions are negative. At $\beta = \beta_c$, $Z_{+,+}^0(\mathbf{0})$ is exactly zero while the other partition functions can be expressed in terms of special functions [16, 43].

The Grassmann representation is particularly convenient for computing energy-energy correlation functions: for instance

$$\langle \varepsilon_{\mathbf{x},j}; \varepsilon_{\mathbf{y},j'} \rangle_{\beta,L}^T \Big|_{\lambda=0} = (1-t^2)^2 \sum_{\alpha} \frac{\tau_\alpha Z_\alpha^0(\mathbf{0})}{2Z^0(\mathbf{0})} \langle E_{\mathbf{x},j}; E_{\mathbf{y},j'} \rangle_{\alpha,L}^T, \quad (1.20)$$

where $\langle \cdot \rangle_{\alpha,L}$ is the average with respect to the Grassmann ‘‘measure’’ $\mathcal{D}\Phi e^{S(\Phi, \mathbf{0})}$ with α boundary conditions; we shall also indicate by $\langle \cdot \rangle_\alpha$ the $L \rightarrow \infty$ limit

of $\langle \cdot \rangle_{\alpha, L}$. As mentioned above, if $\beta \neq \beta_c$ then $\langle E_{\mathbf{x}, j}; E_{\mathbf{y}, j'} \rangle_{\alpha, L}^T$ is *exponentially insensitive* to boundary conditions as $L \rightarrow \infty$, so that, for all $\beta \neq \beta_c$,

$$\lim_{L \rightarrow \infty} \langle \varepsilon_{\mathbf{x}, j}; \varepsilon_{\mathbf{y}, j'} \rangle_{\beta, L}^T \Big|_{\lambda=0} = (1 - t^2)^2 \langle E_{\mathbf{x}, j}; E_{\mathbf{y}, j'} \rangle_{-, -}^T. \quad (1.21)$$

A similar formula is true for the m -point functions, $m \geq 2$:

$$\lim_{L \rightarrow \infty} \langle \varepsilon_{\mathbf{x}_1, j_1}; \dots; \varepsilon_{\mathbf{x}_m, j_m} \rangle_{\beta, L}^T \Big|_{\lambda=0} = (1 - t^2)^m \langle E_{\mathbf{x}_1, j_1}; \dots; E_{\mathbf{x}_m, j_m} \rangle_{-, -}^T, \quad (1.22)$$

valid for all $\beta \neq \beta_c$. As mentioned above, if $\lambda = 0$ the Grassmann ‘‘measure’’ used to compute the r.h.s. of this equation is gaussian (i.e. $S(\Phi, \mathbf{0})$ is quadratic): therefore, the r.h.s. of Eq.(1.22) can be computed via the fermionic Wick rule, leading to a sum over all the Feynman graphs obtained by pairing (‘‘contracting’’) the Grassmann fields involved; truncation means that only connected Feynman diagrams should be considered. From a graphical point of view, Eq.(1.22) can be graphically interpreted as a sum over simple *loop graphs*, as in Fig.1. The fermionic representation outlined above also allows one to compute the spin-spin correlations, even though these are represented by much more involved expressions. In particular, if $x > 0$,

$$\langle \sigma_{(x,0)} \sigma_{0,0} \rangle_{\beta, L} \Big|_{\lambda=0} = t^x \langle \langle e^{a(t^{-1}-t) \sum_{z=0}^{x-a} E_{(z,0),1}} \rangle \rangle_L, \quad (1.23)$$

where $\langle \langle \cdot \rangle \rangle_L = \sum_{\alpha} \frac{\tau_{\alpha} Z_{\alpha}^0}{2Z^0} \langle \cdot \rangle_{\alpha, L}$. Eq.(1.23) can be equivalently rewritten as

$$\begin{aligned} \log \langle \sigma_{(x,0)} \sigma_{0,0} \rangle_{\beta, L} \Big|_{\lambda=0} &= x \log t + \\ &+ \sum_{m \geq 1} \frac{(t^{-1} - t)^m}{m!} a^m \sum_{z_1=0}^{x-a} \dots \sum_{z_m=0}^{x-a} \langle \langle E_{(z_1,0),1}; \dots; E_{(z_m,0),1} \rangle \rangle_L^T. \end{aligned} \quad (1.24)$$

In other words, the spin-spin correlation can be expressed as a series of truncated energy correlations. Such representation is not very manageable and the asymptotic behavior of $\langle \sigma_{(x,0)} \sigma_{0,0} \rangle_{\beta} \Big|_{\lambda=0}$ at or close to the critical point is usually derived by the (equivalent) representation in term of a determinant of an $x \times x$ matrix [43], even though several attempts have been pursued along the years to resum such series (see below).

In any case, the above Grassmann representation looks quite different from those describing relativistic QFT fermionic models. However, we can perform a suitable change of variables [32] from $\{\bar{H}_{\mathbf{x}}, H_{\mathbf{x}}, \bar{V}_{\mathbf{x}}, V_{\mathbf{x}}\}$ to the *critical modes* $\{\psi_{\mathbf{x}, \pm}, \chi_{\mathbf{x}, \pm}\}$, see next section for a precise definition; the propagator of the ψ field is massless at the critical point, while the χ field is

uniformly massive. After the integration of the massive modes, which can be performed exactly, we find that if $\lambda = 0$

$$\langle \psi_{\mathbf{x}_1, \omega_1} \cdots \psi_{\mathbf{x}_n, \omega_n} \rangle_{\alpha, L} = \frac{1}{\mathcal{N}_\alpha} \int \left[\prod_{\substack{\mathbf{x} \in \Lambda_L^a \\ \omega = \pm}} d\psi_{\mathbf{x}, \omega} \right] e^{\bar{S}(\psi)} \psi_{\mathbf{x}_1, \omega_1} \cdots \psi_{\mathbf{x}_n, \omega_n} \quad (1.25)$$

where \mathcal{N}_α is a normalization and, if $\psi_{\mathbf{x}} = \begin{pmatrix} \psi_{\mathbf{x}, +} \\ \psi_{\mathbf{x}, -} \end{pmatrix}$,

$$\bar{S}(\psi) = -\frac{1}{4\pi} \int d\mathbf{x} \psi_{\mathbf{x}}^T \begin{pmatrix} \hat{\partial}_1 + i\hat{\partial}_2 & i\sigma + \hat{\Delta}_a \\ -i\sigma - \hat{\Delta}_a^\dagger & \hat{\partial}_1 - i\hat{\partial}_2 \end{pmatrix} \psi_{\mathbf{x}} \quad (1.26)$$

where $\hat{\partial}_j$ is a lattice approximation of the derivative in the j -th coordinate direction, $\hat{\Delta}_a$ is a second order lattice differential operator, formally vanishing as $a \rightarrow 0$, and $\sigma = \frac{2}{a} \frac{t-t_c(0)}{t_c(0)}$ is the mass, where $t_c(0) = \sqrt{2} - 1$. Remarkably, the above functional integral coincides with the lattice regularization of a QFT describing Majorana fermions in $d = 1 + 1$ dimensions, with a Wilson term (the second order operator $\hat{\Delta}_a$) which allows one to avoid the fermion doubling problem [32].

Once again, the r.h.s. of Eq.(1.25) can be computed exactly in terms of the fermionic Wick rule, with propagator given by the covariance of the quadratic form in Eq.(1.26). In the scaling limit, this propagator tends to \mathbf{g}^0 of Eq.(1.9); correspondingly, the r.h.s. of Eq.(1.22), after the change of variables from $\{\bar{H}_{\mathbf{x}}, H_{\mathbf{x}}, \bar{V}_{\mathbf{x}}, V_{\mathbf{x}}\}$ to $\{\psi_{\mathbf{x}, \pm}, \chi_{\mathbf{x}, \pm}\}$ and the integration of the χ fields, tends to the r.h.s. of Eq.(1.8). If $m^*=0$, the limiting theory is a scale-free relativistic Conformal Field Theory (CFT). Conformal invariance appears to be a robust property, stable under changes in the shape of the box and of the underlying lattice, as proved by Chelkak and Smirnov [15] by making use of suitable fermionic operators on the lattice [48] and the ideas of Schramm-Lowner Evolution (SLE) [38].

While the discussion of the continuum limit of the energy correlations starting from the exact solution (that is, from the Grassmann integral representation) is straightforward and fully rigorous, the analogous discussion for the spin-spin correlation is much harder. One tempting route to its computation is to start from Eq.(1.24) and then replace the sums by integrals and the energy truncated expectations by their scaling limit Eq.(1.8); this is the strategy followed by [2, 17, 58]. However, these replacements introduce spurious ultraviolet divergences that require a suitable interpretation; some justification of this procedure has been provided by Dotsenko and Dotsenko [17], but it is fair to say that so far there is no mathematically sound way to

resum the series in Eq.(1.24) to get the spin-spin correlation. A better alternative approach is based on bosonization, which connects this (among many other quantities) to observables of a discrete height model [19]. This height model has long been known to converge in a weak sense to the Gaussian free field [37], and a recent preprint by Dubédat [18] extends this convergence to the relevant class of observables.

Let us return now to the *non integrable* model Eq.(1.1) with $\lambda \neq 0$. A basic principle in statistical physics, which has a wide experimental confirmation, is *universality* [5, 20, 29], which tells us in particular that the physical properties of a system close to a second order phase transitions are largely independent of the microscopic details of the interaction among its elementary components: only a few general properties related to dimensionality and the symmetries of the Hamiltonian matter as far as the computation of its critical exponents is concerned. It is widely believed that the Ising model with finite range interactions Eq.(1.1) belongs to the same class of universality as the n.n. Ising model, that is, the critical exponents of the two models are the same. On the other hand, other physical quantities, like the critical temperature, are expected to be non-universal. However, a mathematical proof of this conjecture is very difficult: universality in two dimensions is not a trivial issue at all. A striking illustration of this fact is provided by the exact solution of the eight vertex model by Baxter [4], which came after the solution of the six vertex model by Lieb [40], and showed that the critical exponents of these vertex models are continuous non trivial functions of the coupling. Eight vertex models can be represented equivalently as a pair of Ising models coupled by a four spin interaction [5]; therefore, the Ising universality class should be stable under in-layer perturbations, but not against perturbations coupling two different layers. The classification of the possible critical theories close to the Ising model is by itself a very rich and interesting research field. It is based on the remark, due to Belavin, Polyakov and Zamolodchikov [6], that if a 2D critical theory admits a scaling limit, this should be invariant under the infinite dimensional group of conformal transformations of the complex plane. Such a large symmetry group imposes infinitely many constraints on the correlation functions and in some cases these are sufficient to compute them in closed form. Even more strikingly, in many cases the critical exponents are all functions of a single parameter, the central charge c , which in turn can be computed from the self-correlation of the energy-momentum tensor $T(z)$, $\langle T(z)T(0) \rangle = \frac{c}{2z^4}$ [6, 33]. In our case, $T(z) = -\frac{1}{2}\psi\partial\psi$ and $\langle T(z)T(0) \rangle = \frac{1}{4z^4}$, from which $c = \frac{1}{2}$ and the simplest conformal field theory with central charge 1/2 has two primary fields with critical exponents 2 and 1/4, respectively, which are naturally identified with

the energy and the spin operators of the continuum limit of the critical Ising model [6, 33]. Universality and conformal invariance of the nearest neighbor Ising model on regular lattices and domains of different shapes has been recently proved by Smirnov [53], Chelkak and Smirnov [15] and by Chelkak, Hongler and Izyurov [14], by SLE methods. However, it should be stressed that the results of Smirnov, Chelkak and collaborators heavily rely on the underlying integrability properties of the nearest neighbor Ising model and are very fragile under perturbations of the form Eq.(1.1). The problem of proving the existence of the scaling limit of the critical theory Eq.(1.1) at $\lambda \neq 0$ and of its conformal invariance still remains a big challenge.

A different approach to universality which is suitable to include perturbations of the form Eq.(1.1) is provided by the Renormalization Group [56]. A rigorous application of this idea to the present context has been proposed by Pinson and Spencer [47, 54]. As mentioned above, their starting point is an exact expression of the partition function of certain non-integrable Ising models in terms of a non-gaussian Grassmann integral, which can be studied by constructive QFT methods, similar to those used by Lesniewski [39] to analyze the Yukawa₂ QFT: in both cases the interaction is *irrelevant* in the Renormalization Group sense. Using such methods, Pinson and Spencer proved that the critical exponent of the energy correlation is independent of the next-to-nearest-neighbor interaction, provided this is chosen of a suitable form. Their proof provides the first example of universality of a critical exponent in a perturbed 2D Ising model. This approach based on fermionic mapping and constructive Renormalization Group analysis can be applied to coupled Ising models, like the Eight Vertex or the Ashkin-Teller model; in such cases, as shown by Mastropietro [41], the interaction becomes *marginally relevant* in the Renormalization Group sense and the energy exponents are non universal continuous function of the coupling. Extensions of such methods allowed Benfatto, Falco and Mastropietro to prove the Kadanoff relations [34] between the specific heat, the energy and the crossover critical exponents in eight vertex and Ashkin-Teller models [8]; they also allowed Giuliani and Mastropietro to compute a new critical exponent controlling the crossover from universal to non-universal behavior in the asymmetric Ashkin-Teller model [27]. It should be remarked that these exponents cannot be computed by other means, since the Ashkin-Teller model is not solvable (and we also recall that the eight vertex model is solvable but only certain exponents can be deduced from the solution).

In this paper we extend the analysis of Pinson and Spencer [47, 54] in several directions. First, we generalize the class of spin perturbations that can be considered: while they required special next-to-nearest neighbor in-

teractions, we just need the function v in Eq.(1.1) to be of finite range and symmetric under the natural lattice symmetries; the resulting exact fermionic action is defined in terms of an exponentially decaying self-interaction of the involved Grassmann field, see Proposition 1 in Section 2.1 below. It should be noted that even though the interaction in terms of spins is finite range, the corresponding fermionic interaction is of infinite range and of arbitrary high degree in the fermionic field, but exponentially decaying on the scale of the lattice. The result is based on a first cluster expansion, which is exponentially convergent provided that the strength λ of the perturbation is small enough. Second, we combine the analysis of Pinson and Spencer with one used by Benfatto, Falco and Mastropietro [7] to prove and control the convergence of its energy correlations to the continuum limit. In this way, besides the critical exponent of the 2-point energy correlation, we can explicitly compute the scaling limit of all the multipoint correlation functions: in particular we have a constructive procedure to compute the amplitude of the energy correlations and the subdominant corrections that vanish in the scaling limit. As a technical point, let us also mention that, as compared to [7], our bound on the subdominant corrections is optimal from a combinatorial point of view: it grows as $m!$ as $m \rightarrow \infty$, exactly as the dominant term, contrary to the bound in [7], which grows as $(m!)^\alpha$, $\alpha > 1$. Our results can be seen as a strong statement of universality with respect to perturbations of the form Eq.(1.1): the critical correlations in the scaling limit have the same analytical expression as those of the n.n. Ising model, up to a renormalization of the wave function and of the mass.

Of course, many important problems remain to be faced. One is to repeat the analysis for the energy correlations on the torus, taking the scaling limit directly at the critical point. However, the most urgent problem is to prove universality of the spin critical exponent. As we have seen before, the explicit expressions for the energy correlations of the Ising model have been used by Dotsenko and Dotsenko [17] to compute the spin-spin critical exponent (modulo a number of audacious exchange of limits). The spin-spin correlation for the model Eq.(1.1) with $\lambda \neq 0$ can be still expressed by a formula similar to Eq.(1.24), with $(t^{-1} - t)$ replaced by a renormalized coefficient t_λ and the free truncated energy correlations replaced by the interacting ones at $\lambda \neq 0$. If we proceed as in [17] and, in the scaling limit, we replace the sums in Eq.(1.24) by integrals and the truncated energy correlations by their limiting value, we get an expression essentially identical to the non interacting one, with the important difference that the m -th order term in the series has a prefactor proportional to $(t_\lambda \bar{Z}(\lambda))^m$. After a resummation (if formal) of the series, the factor $t_\lambda \bar{Z}(\lambda)$ appears to be related to the critical exponent of the spin-spin

correlation. In this perspective, the proof of universality for this exponent could be reduced to the proof that the combination $t_\lambda \bar{Z}(\lambda)$ is identically 1 as a function of λ . However, one might worry that the exchange of the scaling limit with the integrals could produce an extra finite renormalization that could be difficult to control; this question requires further investigation. Another possible strategy for determining the exponent of the spin-spin correlation is by computing the self-correlation of the energy-momentum tensor: if we could identify the right lattice counterpart of this operator (which is usually defined directly in the scaling limit) then we could have direct access to the central charge of the interacting theory (which should be $1/2$ if the universality principle is correct).

The rest of the paper is devoted to the proofs of Theorems 1.1 and 1.2. In Section 2 we prove the Grassmann representation of the generating function for the multi-point energy correlations. In Section 3 we describe the Renormalization Group procedure used to control the Grassmann generating function uniformly in the mass m^* . Finally, in Section 4 we explain how to adapt the general expansion and the bounds discussed in Section 3 to the multi-point energy correlation functions and conclude the proof of the two theorems stated above.

2 The representation of the interacting Ising model in Grassmann variables

2.1 The generating function for the energy correlations

Consider the model Eq.(1.1) where $v(\mathbf{x})$ has the properties spelled after Eq.(1.1). Without loss of generality we can assume that the additional nearest neighbor interaction is zero: $v(a\hat{\mathbf{e}}_j) = 0$, $j = 1, 2$. The interaction is written in terms of the macroscopic coordinates for a unified notation, but in fact depends on the lattice distance; that is $v(\mathbf{x} - \mathbf{y}) = v_0(\frac{\mathbf{x}-\mathbf{y}}{a})$ for some v_0 independent of a . We shall assume that v is normalized in such a way that $\frac{1}{2} \sum_{\mathbf{x}} |v(\mathbf{x})| = 1$. For notational simplicity, we shall also assume that $a = \ell_0 2^{-N}$, where ℓ_0 is the macroscopic unit length and $N \in \mathbb{N}$. Moreover, we define \mathcal{B}_M^a to be the set of nearest neighbor bonds in $\Lambda_L^a = a\mathbb{Z}_M^2$.

As reviewed in the previous section, in the simple Ising model case ($\lambda = 0$), the generating function for the energy correlations can be represented in terms of a gaussian Grassmann integral, see Eqs.(1.17)-(1.18). A similar

representation in terms of a non-gaussian Grassmann integral is valid also in the $\lambda \neq 0$ case, as stated in the following proposition and proved below.

Proposition 1. *There exists $\lambda_0 > 0$ such that, if $|\lambda| \leq \lambda_0$, then for any m -tuple of distinct pairs $(\mathbf{x}_1, j_1), \dots, (\mathbf{x}_m, j_m)$, with $m \geq 2$, $\mathbf{x}_i \in \Lambda_M^a$ and $j_i \in \{1, 2\}$,*

$$\langle \varepsilon_{\mathbf{x}_1, j_1}; \dots; \varepsilon_{\mathbf{x}_m, j_m} \rangle_{\beta, L}^T = a^{-2m} \frac{\partial^m}{\partial A_{\mathbf{x}_1, j_1} \dots \partial A_{\mathbf{x}_m, j_m}} \log \Xi(\mathbf{A}) \Big|_{\mathbf{A}=\mathbf{0}}, \quad (2.1)$$

where $\Xi(\mathbf{A})$ is the Grassmann generating functional

$$\Xi(\mathbf{A}) = \frac{C_M}{2} \sum_{\alpha \in \{\pm\}^2} \tau_\alpha \int \mathcal{D}\Phi e^{S_t(\Phi) + (1-t^2)(\mathbf{E}, \mathbf{A}) + \mathcal{V}(\Phi, \mathbf{A})} \quad (2.2)$$

where $t := \tanh(\beta J)$, $(\mathbf{E}, \mathbf{A}) := \sum_{j=1}^2 \int d\mathbf{x} E_{\mathbf{x}, j} A_{\mathbf{x}, j}$ and:

- C_M is a normalization constant, defined as

$$C_M = (-2a^{-2} \cosh^2(\beta J))^{M^2} e^{V_M(\lambda)} \prod_{\{\mathbf{x}, \mathbf{y}\}} \cosh^2\left(\frac{\beta\lambda}{2} v(\mathbf{x} - \mathbf{y})\right) \quad (2.3)$$

with $V_M(\lambda)$ an analytic function of λ , independent of a and satisfying the bound $|V_M(\lambda)| \leq C|\lambda|M^2$, for a suitable $C > 0$;

- $S_t(\Phi)$ is the unperturbed quadratic part of the action, defined as

$$S_t(\Phi) = a \sum_{\mathbf{x} \in \Lambda_L^q} (tE_{\mathbf{x}, 1} + tE_{\mathbf{x}, 2} + \bar{H}_{\mathbf{x}} H_{\mathbf{x}} + \bar{V}_{\mathbf{x}} V_{\mathbf{x}} + \bar{V}_{\mathbf{x}} \bar{H}_{\mathbf{x}} + V_{\mathbf{x}} \bar{H}_{\mathbf{x}} + H_{\mathbf{x}} \bar{V}_{\mathbf{x}} + V_{\mathbf{x}} H_{\mathbf{x}}) \quad (2.4)$$

- $\mathcal{V}(\Phi, \mathbf{A})$ is a polynomial in $\{E_{\mathbf{x}, j}\}_{\mathbf{x} \in \Lambda_M^q}^{j=1,2}$ and $\{A_{\mathbf{x}, j}\}_{\mathbf{x} \in \Lambda_M^q}^{j=1,2}$, which can be expressed as

$$\mathcal{V}(\Phi, \mathbf{A}) = \sum_{\substack{n, m \geq 0 \\ n+m \geq 1}} \sum_{\substack{j_1, \dots, j_n \\ j'_1, \dots, j'_m}} \int d\mathbf{x}_1 \dots d\mathbf{x}_n d\mathbf{y}_1 \dots d\mathbf{y}_m \cdot \quad (2.5)$$

$$\cdot W_{\underline{j}, \underline{j}'}(\mathbf{x}_1, \dots, \mathbf{x}_n; \mathbf{y}_1, \dots, \mathbf{y}_m) \prod_{i=1}^n E_{\mathbf{x}_i, j_i} \prod_{i'=1}^m A_{\mathbf{y}_{i'}, j'_{i'}}$$

where $\underline{j} = (j_1, \dots, j_n)$, $\underline{j}' = (j'_1, \dots, j'_m)$ and, if $\underline{\mathbf{x}} = (\mathbf{x}_1, \dots, \mathbf{x}_n)$ and $\underline{\mathbf{y}} = (\mathbf{y}_1, \dots, \mathbf{y}_m)$,

$$|W_{\underline{j}, \underline{j}'}(\underline{\mathbf{x}}; \underline{\mathbf{y}})| \leq C^{n+m} (\beta|\lambda|)^{\max\{1, c(n+m)\}} a^{-(2-n-m)} \frac{e^{-\kappa \delta(\underline{\mathbf{x}}, \underline{\mathbf{y}})/a}}{a^{2(n+m-1)}} \quad (2.6)$$

for suitable constants $C, c, \kappa > 0$ depending only on M_0 (the range of the interaction); here $\delta(\mathbf{x}_1, \dots, \mathbf{y}_m)$ is the tree distance of the set $X = \{\mathbf{x}_1, \dots, \mathbf{y}_m\}$, that is the length of the shortest tree graph composed of bonds in \mathcal{B}_M^a which connects all the elements of X .

Remark. The factor $\frac{e^{-\kappa\delta(\mathbf{x},\mathbf{y})/a}}{a^{2(n+m-1)}}$ in Eq.(2.6) is normalized in such a way that its L_1 norm is essentially independent of a , that is

$$\frac{1}{L^2} \int d\mathbf{x}_1 \cdots d\mathbf{y}_m \frac{e^{-\kappa\delta(\mathbf{x},\mathbf{y})/a}}{a^{2(n+m-1)}} \leq C_\kappa$$

where C_κ is a constant independent of a . On the other hand, the factor $(\beta|\lambda|)^{\max\{1, c(n+m)\}}$ measures the smallness in λ of the kernel W , while the factor $a^{-(2-n-m)}$ (or, better, its a -dimensional version, $(a/\ell_0)^{-(2-n-m)}$) plays the role of its *scaling dimension*. Recall that $a/\ell_0 = 2^{-N}$, see the beginning of Section 2.1: therefore, the scaling dimension of the kernel can be rewritten as $2^{N(2-n-m)}$. We shall see in the following that the generating function can be integrated by an iterative multiscale procedure; at each step, it will be expressed in terms of an effective potential on scale h , with $h \leq N$, analogous to $\mathcal{V}(\Phi, \mathbf{A})$, whose kernels $W^{(h)}$ have decay properties analogous to W , with the important difference that the scale 2^N is replaced by 2^h and, therefore, the scaling dimension $2^{N(2-n-m)}$ is replaced by $2^{h(2-n-m)}$. The result of the iteration, as $h \rightarrow -\infty$, gives the generating function of interest. The relevant scaling properties of the multi-point energy correlation function as $a \rightarrow 0$ and $\beta \rightarrow \beta_c$ will be controlled in terms of the kernels $W^{(h)}$ and of their limits as $N \rightarrow \infty$ and $h \rightarrow -\infty$.

Proof of Proposition 1. For notational convenience, given a bond $b \in \mathcal{B}_M^a$, we denote by ε_b , E_b and A_b the corresponding bond operators: that is, if $b = (\mathbf{x}, \mathbf{x} + a\hat{\mathbf{e}}_1)$ (resp. $b = (\mathbf{x}, \mathbf{x} + a\hat{\mathbf{e}}_2)$), then $\varepsilon_b = \varepsilon_{\mathbf{x},1}$, $E_b = E_{\mathbf{x},1}$ and $A_b = A_{\mathbf{x},1}$ (resp. $\varepsilon_b = \varepsilon_{\mathbf{x},2}$, $E_b = E_{\mathbf{x},2}$ and $A_b = A_{\mathbf{x},2}$). The key to the first step in the proof is the remark is that if b_1, \dots, b_n are n *distinct* bonds, then the Grassmann representation for the nearest neighbor Ising model induces the following:

$$\begin{aligned} \sum_{\sigma \in \Omega_M} e^{\sum_b (\beta J + a A_b) a \varepsilon_b} \varepsilon_{b_1} \cdots \varepsilon_{b_n} &= \frac{1}{2} \sum_{\alpha} \tau_{\alpha} a^{-2n} \frac{\partial^n}{\partial A_{b_1} \cdots \partial A_{b_n}} Z_{\alpha}^0(\mathbf{A}) = \\ &= \frac{1}{2} \sum_{\alpha} \tau_{\alpha} (-2a^{-2})^{M^2} \left[\prod_{b \in \mathcal{B}_M^a} \cosh(\beta J + a A_b) \right] \cdot \\ &\cdot \int \mathcal{D}\Phi (a^{-1} t_{b_1} + (1 - t_{b_1}^2) E_{b_1}) \cdots (a^{-1} t_{b_n} + (1 - t_{b_n}^2) E_{b_n}) e^{S(\Phi, \mathbf{A})}, \end{aligned} \quad (2.7)$$

where $t_b = \tanh(\beta J + aA_b)$. This correspondence is invalid for repeated bond variables: note that $[a^{-1}t_b + (1 - t_b^2)E_b]^2 = a^{-2}t_b^2 + 2a^{-1}(1 - t_b^2)^2E_b$, while $\varepsilon_b^2 = a^{-2}$. This last observation can be used to remove repeated bond operators from any expression; therefore, in order to derive a Grassmann representation for $Z(\mathbf{A})$, it is enough to express the interaction term (i.e. the λ -dependent term) in Eq.(1.7) as sum of products of *distinct* bond operators; then we can replace every bond operator ε_b by $a^{-1}t_b + (1 - t_b^2)E_b$, in the sense explained above, and finally we can re-exponentiate the big sum of products of Grassmann variables, so obtaining the desired Grassmann functional integral representation of the Ising model at hand. This can be implemented as follows. By definition,

$$Z(\mathbf{A}) = \sum_{\sigma \in \Omega_M} e^{\sum_b (\beta J + aA_b) a \varepsilon_b} \prod_{\{\mathbf{x}, \mathbf{y}\}} e^{\beta \lambda \sigma_{\mathbf{x}} v(\mathbf{x} - \mathbf{y}) \sigma_{\mathbf{y}}} . \quad (2.8)$$

Consider a pair of sites $\{\mathbf{x}, \mathbf{y}\}$ contributing to the product in the r.h.s. of this equation, i.e., a pair of sites such that $|\mathbf{x} - \mathbf{y}| \leq R_0$. Note that $\sigma_{\mathbf{x}} \sigma_{\mathbf{y}}$ can be rewritten in terms of a product of energy density operators localized along a path connecting \mathbf{x} and \mathbf{y} on the lattice: $\sigma_{\mathbf{x}} \sigma_{\mathbf{y}} = \frac{1}{2} U_{\mathbf{x}, \mathbf{y}} + \frac{1}{2} D_{\mathbf{x}, \mathbf{y}}$, where $U_{\mathbf{x}, \mathbf{y}} = \prod_{b \in \mathcal{C}_U(\mathbf{x}, \mathbf{y})} a \varepsilon_b$ and $D_{\mathbf{x}, \mathbf{y}} = \prod_{b \in \mathcal{C}_D(\mathbf{x}, \mathbf{y})} a \varepsilon_b$. Here $\mathcal{C}_U(\mathbf{x}, \mathbf{y})$ and $\mathcal{C}_D(\mathbf{x}, \mathbf{y})$ (where U and D stand for “up” and “down”) are the two paths connecting \mathbf{x} and \mathbf{y} on the lattice described in Fig. 3. Note that we choose paths in this way in order to be sure that we have an expression which manifestly retains the rotation and reflection symmetries of the original interaction. In terms of these “string operators”, we can use the identity

$$e^{\pm x} = \cosh x (1 \pm \tanh x)$$

and the fact that $U, D = \pm 1$ to rewrite the product in the r.h.s. of Eq.(2.8) as:

$$\begin{aligned} \prod_{\{\mathbf{x}, \mathbf{y}\}} e^{\beta \lambda \sigma_{\mathbf{x}} v(\mathbf{x} - \mathbf{y}) \sigma_{\mathbf{y}}} &= \prod_{\{\mathbf{x}, \mathbf{y}\}} e^{\frac{\beta \lambda}{2} v(\mathbf{x} - \mathbf{y}) (U_{\mathbf{x}, \mathbf{y}} + D_{\mathbf{x}, \mathbf{y}})} = \left[\prod_{\{\mathbf{x}, \mathbf{y}\}} \cosh^2 \left(\frac{\beta \lambda}{2} v(\mathbf{x} - \mathbf{y}) \right) \right] \cdot \\ &\cdot \left[\prod_{\{\mathbf{x}, \mathbf{y}\}} \left(1 + \tanh \left(\frac{1}{2} \beta \lambda v(\mathbf{x} - \mathbf{y}) \right) U_{\mathbf{x}, \mathbf{y}} \right) \left(1 + \tanh \left(\frac{1}{2} \beta \lambda v(\mathbf{x} - \mathbf{y}) \right) D_{\mathbf{x}, \mathbf{y}} \right) \right] . \end{aligned}$$

The second line is a product of binomials, each consisting of 1 plus a non trivial term; these non trivial terms can each be graphically associated with a “string” S (i.e., the union of the bonds in $\mathcal{C}_U(\mathbf{x}, \mathbf{y})$ or $\mathcal{C}_D(\mathbf{x}, \mathbf{y})$), either of type U or D, depending on whether it is associated to the path $\mathcal{C}_U(\mathbf{x}, \mathbf{y})$ or $\mathcal{C}_D(\mathbf{x}, \mathbf{y})$; in both cases we shall write $v_S := v(\mathbf{x} - \mathbf{y})$. Note that the assumption that the interaction has range aM_0 means that all of the strings

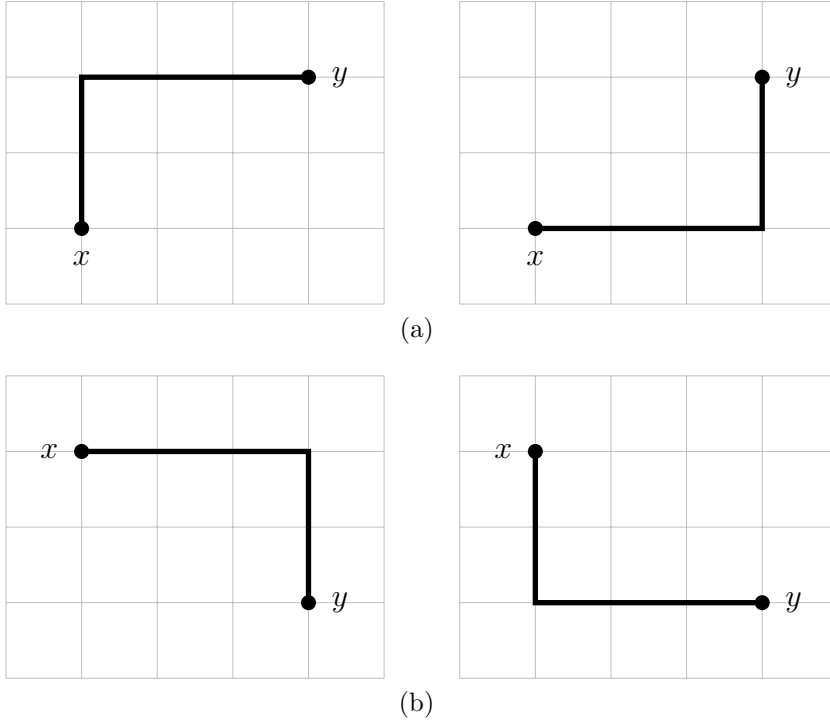

Figure 3: The two paths $\mathcal{C}_U(\mathbf{x}, \mathbf{y})$ (on the left) and $\mathcal{C}_D(\mathbf{x}, \mathbf{y})$ (on the right) in the two cases where: (a) $x_1 < y_1$ and $x_2 < y_2$; (b) $x_1 < y_1$ and $x_2 > y_2$. If $x_1 = y_1$ or $x_2 = y_2$, we choose $\mathcal{C}_U(\mathbf{x}, \mathbf{y}) = \mathcal{C}_D(\mathbf{x}, \mathbf{y})$ to be the horizontal or vertical segment connecting \mathbf{x} with \mathbf{y} ; this means that horizontal or vertical strings are counted twice.

we are considering consist of no more than M_0 bonds. If we now expand the product

$$\left[\prod_{\{\mathbf{x}, \mathbf{y}\}} \left(1 + \tanh\left(\frac{1}{2}\beta\lambda v(\mathbf{x} - \mathbf{y})\right) U_{\mathbf{x}, \mathbf{y}} \right) \left(1 + \tanh\left(\frac{1}{2}\beta\lambda v(\mathbf{x} - \mathbf{y})\right) D_{\mathbf{x}, \mathbf{y}} \right) \right]$$

we get a sum over all subsets of the collection of strings which appear in the interaction under consideration, in which each term is a product of string operators. Moreover, every such subset can be thought of as a collection of its maximal connected components (here we say that a set of strings $\mathcal{S} = \{S_1, \dots, S_m\}$ is connected if, given $1 \leq i_0 < j_0 \leq m$, we can find a sequence $(S_{i_0}, S_{i_1}, \dots, S_{i_p} \equiv S_{j_0})$ such that $S_{i_l} \cap S_{i_{l+1}} \neq \emptyset$). From a graphical point of view, every connected component \mathcal{S} corresponds in a non-unique way to a polymer $\gamma(\mathcal{S})$, i.e., a connected set of bonds. It is helpful to color the bonds in $\gamma(\mathcal{S})$ black or gray, depending on whether the given bond belongs to an odd or even number of strings in \mathcal{S} , and denote the set of bonds thus colored

black by $\text{bl}(\mathcal{S})$. We call the collection of terms associated with a polymer γ the activity of γ and denote it by $z(\gamma)$ and noting that $a^2\varepsilon_b^2 \equiv 1$

$$z(\gamma) = \sum_{\substack{\mathcal{S} \text{ connected:} \\ \gamma(\mathcal{S})=\gamma}} \left[\prod_{S \in \mathcal{S}} \tanh\left(\frac{1}{2}\beta\lambda v_S\right) \right] \left[\prod_{b \in \text{bl}(\mathcal{S})} a\varepsilon_b \right], \quad (2.9)$$

in terms of which we can finally rewrite

$$\prod_{\{\mathbf{x}, \mathbf{y}\}} e^{\beta\lambda\sigma_{\mathbf{x}}v(\mathbf{x}-\mathbf{y})\sigma_{\mathbf{y}}} = \left[\prod_{\{\mathbf{x}, \mathbf{y}\}} \cosh^2\left(\frac{1}{2}\beta\lambda v(\mathbf{x}-\mathbf{y})\right) \right] \sum_{\Gamma \subseteq \Lambda} \varphi(\Gamma) \prod_{\gamma \in \Gamma} z(\gamma) \quad (2.10)$$

where the sum $\sum_{\Gamma \subseteq \Lambda}$ in the r.h.s. runs over sets of polymers, $\Gamma = \{\gamma_1, \dots, \gamma_n\}$, to be called *polymer collections*, such that each polymer is contained in $\Lambda = \Lambda_M^a$, i.e. it is formed by bonds in \mathcal{B}_M^a . Moreover, the function $\varphi(\{\gamma_1, \dots, \gamma_n\})$ implements the hard core condition, that is φ is equal to 1 if none of the polymers overlap, and 0 otherwise; the term with $\Gamma = \emptyset$ should be interpreted as 1. Note that the r.h.s. of Eq. (2.10), like that of (2.9), is multilinear in the bond variables (i.e., each bond variable ε_b appears at most once in every term in the sum). Hence, plugging Eq.(2.10) into Eq.(2.8) and using Eq.(2.7), we find:

$$Z(\mathbf{A}) = \sum_{\alpha} \frac{\tau_{\alpha}}{2} (-2a^{-2})^{M^2} \left[\prod_{b \in \mathcal{B}_M^a} \cosh(\beta J + aA_b) \right] \left[\prod_{\{\mathbf{x}, \mathbf{y}\}} \cosh^2\left(\frac{1}{2}\beta\lambda v(\mathbf{x}-\mathbf{y})\right) \right] \cdot \int \mathcal{D}\Phi \sum_{\Gamma \subseteq \Lambda} \varphi(\Gamma) \left[\prod_{\gamma \in \Gamma} \tilde{\zeta}_G(\gamma) \right] e^{S(\Phi, \mathbf{A})}, \quad (2.11)$$

where

$$\tilde{\zeta}_G(\gamma) = \sum_{\substack{\mathcal{S} \text{ connected:} \\ \gamma(\mathcal{S})=\gamma}} \prod_{S \in \mathcal{S}} \tanh\left(\frac{1}{2}\beta\lambda v_S\right) \prod_{b \in \text{bl}(\mathcal{S})} (t_b + a(1 - t_b^2)E_b), \quad (2.12)$$

This is exactly the sort of expression which is the subject of the standard cluster expansion (for a presentation in a convenient form, see [22, Chap. 7]), which gives the identity

$$\sum_{\Gamma \subseteq \Lambda} \varphi(\Gamma) \prod_{\gamma \in \Gamma} \tilde{\zeta}_G(\gamma) = \exp \left\{ \sum_{\Gamma \subseteq \Lambda} \varphi^T(\Gamma) \prod_{\gamma \in \Gamma} \tilde{\zeta}_G(\gamma) \right\} \quad (2.13)$$

which is valid provided that the sum in the r.h.s. is absolutely convergent. In the r.h.s. the sum over Γ involves polymer collections that include overlapping and even repeated polymers (we let $\Gamma(\gamma)$ be the multiplicity of γ in

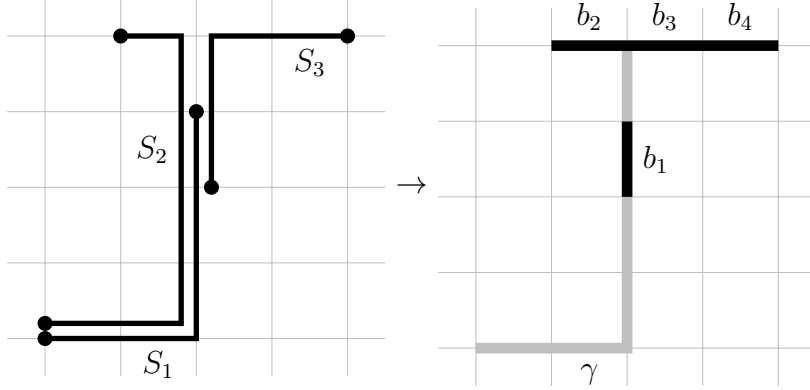

$$\rightarrow \tanh(\frac{1}{2}\beta\lambda v_{S_1})\tanh(\frac{1}{2}\beta\lambda v_{S_2})\tanh(\frac{1}{2}\beta\lambda v_{S_3}) \times \\ (t_{b_1} + (1 - t_{b_1}^2)aE_{b_1})(t_{b_2} + (1 - t_{b_2}^2)aE_{b_2})(t_{b_3} + (1 - t_{b_3}^2)aE_{b_3})(t_{b_4} + (1 - t_{b_4}^2)aE_{b_4})$$

Figure 4: Example of a set of strings $\mathcal{S} = \{S_1, S_2, S_3\}$ and the corresponding coloring of the associated polymer γ . The contribution to $\tilde{\zeta}_G$ associated with \mathcal{S} is given below.

Γ) and $\varphi^T(\{\gamma_1, \dots, \gamma_n\})$ are *Mayer's coefficients*, which admit the following explicit representation. Given $\gamma_1, \dots, \gamma_n$, consider the graph \mathcal{G} with n nodes, labelled by $1, \dots, n$, with edges connecting all pairs i, j such that $\gamma_i \cap \gamma_j \neq \emptyset$ (\mathcal{G} is sometimes called the connectivity graph of the collection of polymers $\gamma_1, \dots, \gamma_n$). Then one has $\varphi^T(\emptyset) = 0$, $\varphi^T(\{\gamma\}) = 1$ and, for $n > 1$:

$$\varphi^T(\{\gamma_1, \dots, \gamma_n\}) = \frac{1}{\Gamma!} \sum_{C \subseteq \mathcal{G}}^* (-1)^{\text{number of edges in } C}, \quad (2.14)$$

where $\Gamma! = \prod_{\gamma} \Gamma(\gamma)!$ and the sum runs over all the connected subgraphs C of G that visit all the n points $1, \dots, n$. In particular, if $n > 1$, then $\varphi^T(\{\gamma_1, \dots, \gamma_n\}) = 0$ unless $\{\gamma_1, \dots, \gamma_n\}$ is connected.

Plugging Eq.(2.13) into Eq.(2.11) gives

$$Z(\mathbf{A}) = \sum_{\alpha} \frac{\tau_{\alpha}}{2} (-2a^{-2})^{M^2} \left[\prod_{b \in \mathcal{B}_M^a} \cosh(\beta J + aA_b) \right] \cdot \\ \cdot \left[\prod_{\{\mathbf{x}, \mathbf{y}\}} \cosh^2(\frac{1}{2}\beta\lambda v(\mathbf{x} - \mathbf{y})) \right] \int \mathcal{D}\Phi e^{S(\Phi, \mathbf{A}) + \tilde{V}(\Phi, \mathbf{A})}, \quad (2.15)$$

with

$$\tilde{V}(\Phi, \mathbf{A}) := \sum_{\Gamma \subseteq \Lambda} \varphi^T(\Gamma) \prod_{\gamma \in \Gamma} \tilde{\zeta}_G(\gamma), \quad (2.16)$$

provided that the r.h.s. of this equation is absolutely convergent, in the following sense: $\tilde{V}(\Phi, \mathbf{A})$ is a polynomial in the Grassmann variables $\{\bar{H}_{\mathbf{x}}, H_{\mathbf{x}}\}$,

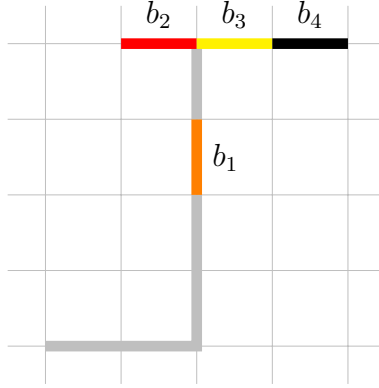

Figure 5: A fully colored contour as used in evaluating W : b_1 is orange, b_2 is red, b_3 is yellow and b_4 is black; the other unlabeled bonds are grey (color online). By definition, the activity of this colored contour is proportional to $(-2t(1-t^2)) aE_{b_1} aA_{b_1} \times (1-t^2) aE_{b_2} \times (1-t^2) aA_{b_3} \times t$.

$\bar{V}_{\mathbf{x}}, V_{\mathbf{x}}\}$, whose coefficients can be written as infinite sums over polymer configurations $\{\gamma_1, \dots, \gamma_n\}$; by absolute convergence of $\tilde{\mathcal{V}}$, we mean that each of these infinite sums are absolutely convergent. As far as the dependence of $\tilde{\mathcal{V}}$ on \mathbf{A} is concerned, we note that since $\tilde{\zeta}_G(\gamma)$ is defined through finite sums and products of hyperbolic tangents $t_b = \tanh(\beta J + aA_b)$, the activities $\tilde{\zeta}_G(\gamma)$ are analytic as functions of each A_b . However, only the terms at most linear in each A_b can contribute to the computation of $\langle \varepsilon_{b_1}; \dots; \varepsilon_{b_m} \rangle_{\beta, L}^T$, with b_1, \dots, b_m all distinct. Therefore, to the purpose of computing these truncated expectations, we can safely replace $\tilde{\zeta}_G(\gamma)$ by its multilinear part in $\{A_b\}_{b \in \mathcal{B}_M^a}$, namely:

$$\tilde{\zeta}_G(\gamma) \rightarrow \zeta_G(\gamma) := \sum_{R \subseteq \gamma} \sum_{Y \subseteq \gamma} \zeta(R, Y; \gamma) \prod_{b \in R} aE_b \prod_{b \in Y} aA_b, \quad (2.17)$$

with

$$\zeta(R, Y; \gamma) := \sum_{\substack{\mathcal{S} \text{ connected: } \mathcal{S} \in \mathcal{S} \\ \gamma(\mathcal{S}) = \gamma \\ \text{bl}(\mathcal{S}) \supseteq R \cup Y}} \prod_{S \in \mathcal{S}} \tanh(\frac{1}{2}\beta\lambda v_S) \prod_{b \in \text{bl}(\mathcal{S})} \begin{cases} t, & b \notin R \cup Y \\ 1 - t^2, & b \in R \Delta Y \\ -2t(1 - t^2), & b \in R \cap Y \end{cases} \quad (2.18)$$

where $(R, Y; \gamma)$ can be associated with a decorated contour where the bonds in R are drawn red, all bonds in Y are drawn yellow, and all bonds in both are drawn orange (see Figure 5). Similarly, we can replace the factor $\left[\prod_{b \in \mathcal{B}_M^a} \cosh(\beta J + aA_b) \right] e^{\mathcal{S}(\Phi, \mathbf{A})}$ in Eq.(2.15) by its multilinear part in

$\{A_b\}_{b \in \mathcal{B}_M^a}$. Performing these replacements corresponds to replacing the generating function in Eq.(2.15) by:

$$Z(\mathbf{A}) \rightarrow e^{at \sum_b A_b} \Xi(\mathbf{A}), \quad (2.19)$$

where $\Xi(\mathbf{A})$ is the same as in Eq.(2.2), with

$$\begin{aligned} V_M(\lambda) + \mathcal{V}(\Phi, \mathbf{A}) &= \sum_{\Gamma \subseteq \Lambda} \varphi^T(\Gamma) \prod_{\gamma \in \Gamma} \zeta_G(\gamma) = \\ &= \sum_{R \subseteq \mathcal{B}_M^a} \sum_{Y \subseteq \mathcal{B}_M^a} W(R, Y) \left[\prod_{b \in R} a E_b \right] \left[\prod_{b \in Y} a A_b \right], \end{aligned} \quad (2.20)$$

and $V_M(\lambda) = W(\emptyset, \emptyset)$. Here the coefficients $W(R, Y)$ are defined as

$$W(R, Y) = \sum_{\substack{n \geq 0 \\ \gamma = (\gamma_1, \dots, \gamma_n)}} \frac{\Gamma(\gamma)!}{n!} \varphi^T(\Gamma(\gamma)) \sum_{\substack{(R_1, \dots, R_n) \in \mathcal{P}_{R, \gamma} \\ (Y_1, \dots, Y_n) \in \mathcal{P}_{Y, \gamma}}} \prod_{j=1}^n \zeta(R_j, Y_j; \gamma_j), \quad (2.21)$$

where $\gamma = (\gamma_1, \dots, \gamma_n)$ is an ordered n -tuple of polymers, $\Gamma(\gamma)$ is the corresponding unordered n -tuple and the combinatorial factor $\frac{\Gamma(\gamma)!}{n!}$ is used to pass from the summation over Γ to the one over γ . Moreover, $\mathcal{P}_{R, \gamma}$ is the set of ordered n -ples of disjoint sets (R_1, \dots, R_n) , such that $R_i \subseteq \gamma_i$ and $\cup_{i=1}^n R_i = R$. Once again, these rewritings are valid provided that the sums entering the definition of $W(R, Y)$ are absolutely convergent. Note also that the prefactor $e^{at \sum_b A_b}$ in the r.h.s. of Eq.(2.19) is irrelevant to the purpose of computing the truncated expectations $\langle \varepsilon_{b_1}; \dots; \varepsilon_{b_m} \rangle_{\beta, L}^T$ with $m \geq 2$, which explains why we did not insert this prefactor in the statement of Proposition 1.

The absolute convergence of Eq.(2.21) follows from an important result in the cluster expansion [22, Proposition 7.1.1], which states (in part) that for any positive function on polymers which decays as

$$f(\gamma) \leq \nu_0^{2|\gamma|} e^{-2\kappa_0 \delta(\gamma)/a} \quad (2.22)$$

for some $\kappa_0 > 0$ and ν_0 sufficiently small (here $|\gamma|$ is the number of bonds in γ), then

$$\sup_b \sum_{\substack{\Gamma = \{\gamma_1, \dots, \gamma_n\} \\ \text{diam}(\cup_j \gamma_j) \geq R \\ \cup_j \gamma_j \ni b}} |\varphi^T(\Gamma)| \prod_{\gamma \in \Gamma} f(\gamma) \leq 2\nu_0 e^{-\frac{\kappa_0}{2} R/a}. \quad (2.23)$$

Actually, the proof of [22, Proposition 7.1.1] implies a slightly more general bound; namely, given $B \subseteq \mathcal{B}_M^a$,

$$\sum_{\substack{\Gamma = \{\gamma_1, \dots, \gamma_n\} \\ \cup_j \gamma_j \supseteq B}} |\varphi^T(\Gamma)| \prod_{\gamma \in \Gamma} f(\gamma) \leq C_1 \nu_0^{c_1 |B|} e^{-c_1 \kappa_0 \delta(B)/a}, \quad (2.24)$$

for two suitable constants $C_1, c_1 > 0$.

To apply this, we first note that the generic contribution to the r.h.s. of Eq.(2.21) vanishes unless the collection $\gamma = (\gamma_1, \dots, \gamma_n)$ is connected and touches all the bonds in $B := R \cup Y$. Therefore,

$$|W(R, Y)| \leq \sum_{\substack{n \geq 0 \\ \gamma = (\gamma_1, \dots, \gamma_n)}} \frac{\Gamma(\gamma)!}{n!} |\varphi^T(\{\gamma_1, \dots, \gamma_n\})| \sum_{\substack{(R_1, \dots, R_n) \in \mathcal{P}_{R, \gamma} \\ (Y_1, \dots, Y_n) \in \mathcal{P}_{Y, \gamma}}} \prod_{j=1}^n |\zeta(R_j, Y_j; \gamma_j)|. \quad (2.25)$$

where

$$\sum_{\substack{(R_1, \dots, R_n) \in \mathcal{P}_{R, \gamma} \\ (Y_1, \dots, Y_n) \in \mathcal{P}_{Y, \gamma}}} \prod_{j=1}^n |\zeta(R_j, Y_j; \gamma_j)| \leq \prod_{j=1}^n \left(\sum_{\substack{R_j \subseteq \gamma_j \\ Y_j \subseteq \gamma_j}} |\zeta(R_j, Y_j; \gamma_j)| \right) \leq \prod_{j=1}^n f(\gamma_j),$$

and

$$f(\gamma) := 4^{|\gamma|} \max_{\substack{R \subseteq \gamma \\ Y \subseteq \gamma}} |\zeta(R, Y; \gamma)| \quad (2.26)$$

plays the role of the function $f(\gamma)$ in the l.h.s. of Eq.(2.24). In order to use the bound Eq.(2.24), we need to prove Eq.(2.22). Using the definition Eq. (2.18) of $\zeta(R, Y, \gamma)$, it is clear that

$$\begin{aligned} f(\gamma) &\leq 4^{|\gamma|} \sum_{\substack{\mathcal{S} \text{ connected: } \mathcal{S} \subseteq \mathcal{S} \\ \gamma(\mathcal{S}) = \gamma}} \prod_{S \in \mathcal{S}} \frac{1}{2} \beta |\lambda v_S| \\ &\leq 4^{|\gamma|} \sum_{m \geq \frac{\delta(\gamma)}{aM_0}} \frac{1}{m!} \left(\frac{\beta |\lambda|}{2} \right)^m \left(\frac{1}{2} \sum_{b \in \gamma} \sum_{S \ni b}^* |v_S| \right)^m, \end{aligned} \quad (2.27)$$

where the $*$ on the sum $\sum_{S \ni b}^* |v_S|$ indicates the constraint that b is either the first or the last bond in S . By using the normalization $\frac{1}{2} \sum_{\mathbf{x}} |v(\mathbf{x})| = 1$ (which means that $\frac{1}{2} \sum_{S \ni b}^* |v_S| = 1$) and defining $m_0 = m_0(\gamma) = \frac{\delta(\gamma)}{aM_0} \equiv \frac{|\gamma|}{M_0}$, we get:

$$\begin{aligned} f(\gamma) &\leq 4^{|\gamma|} \sum_{m \geq m_0} \frac{1}{m!} \left(\frac{\beta |\lambda| |\gamma|}{2} \right)^m \\ &\leq 4^{|\gamma|} \frac{|\gamma|^{m_0}}{m_0!} \left(\frac{\beta |\lambda|}{2} \right)^{m_0} \sum_{m \geq 0} \frac{1}{m!} \left(\frac{\beta |\lambda| |\gamma|}{2} \right)^m \\ &\leq (4e)^{|\gamma|} \left(\frac{\beta |\lambda|}{2} \right)^{m_0} e^{\frac{1}{2} \beta |\lambda| |\gamma|} \equiv \nu_0^{2|\gamma|} e^{-2\kappa_0 \delta(\gamma)/a}, \end{aligned} \quad (2.28)$$

which proves Eq.(2.22) with $\nu_0^2 = 4e^{1+\frac{1}{2}\beta|\lambda|} \left(\frac{\beta|\lambda|}{2}\right)^{\frac{1}{2M_0}}$ and $e^{-2\kappa_0} = \left(\frac{\beta|\lambda|}{2}\right)^{\frac{1}{2M_0}}$. This concludes the proof of the representation Eq.(2.2). The bound Eq.(2.6) on the decay of the kernels of $\mathcal{V}(\Phi, \mathbf{A})$ is just a restatement of the decay bound on $W(R, Y)$ that we just derived (note that the factor $a^{-(2-n-m)}$ comes from the factors a in front of the fields E_b and A_b in Eq.(2.20) and from the definition of $\int d\mathbf{x}$, which brings along a factor a^2 ; in fact, $\int d\mathbf{x} = a^2 \sum_{\mathbf{x} \in \Lambda_M^a}$).

All that remains is to prove the stated properties of $V_M(\lambda) \equiv W(\emptyset, \emptyset)$, where

$$\begin{aligned} W(\emptyset, \emptyset) &= \sum_{\Gamma \subseteq \Lambda} \varphi^T(\Gamma) \prod_{\gamma \in \Gamma} \zeta(\emptyset, \emptyset; \gamma) \\ &= \sum_{b \in \mathcal{B}_M^a} \left[\sum_{\substack{\Gamma \subseteq \Lambda: \\ \text{supp } \Gamma \ni b}} \frac{\varphi^T(\Gamma)}{|\text{supp } \Gamma|} \prod_{\gamma \in \Gamma} \zeta(\emptyset, \emptyset; \gamma) \right], \end{aligned} \quad (2.29)$$

where $\text{supp } \Gamma = \cup_{\gamma \in \Gamma} \gamma$ and $|\text{supp } \Gamma|$ is the number of bonds in $\text{supp } \Gamma$. The sum in square brackets is independent of b , by translation invariance. Moreover, it is independent of a , as it follows by the definition of $\zeta(\emptyset, \emptyset; \gamma)$ and by a relabeling of the lattice spacing a . Therefore, $W(\emptyset, \emptyset)$ can be bounded by $2M^2 s(\lambda)$, where $s(\lambda)$ is a bound on the expression in square brackets. A repetition of the argument used for $W(R, Y)$ above implies that $s(\lambda)$ is of order λ , which concludes the proof of Proposition 1. \square

2.2 Majorana form of the action

As we have shown, the non-integrable Ising model under consideration can be expressed in the form of an interacting fermionic system, described by the action Eq.(2.2), which consists of a leading term, $S_t(\Phi) + \sum_b [t + (1 - t^2)E_b] A_b$, plus an *interaction*, which vanishes as $\lambda \rightarrow 0$ and, in this respect, is “subdominant”. Since in the following we want to treat this subdominant term as a perturbation in the vicinity of the critical point, it is convenient to use coordinates adapted to the critical modes of the leading term, as described in the following.

The Fourier transforms of the Grassmann variables are defined as:

$$\hat{H}_{\mathbf{k}} := a^2 \sum_{\mathbf{x} \in a\mathbb{Z}_M^2} e^{i\mathbf{k} \cdot \mathbf{x}} H_{\mathbf{x}}, \quad \hat{\bar{H}}_{\mathbf{k}} := a^2 \sum_{\mathbf{x} \in a\mathbb{Z}_M^2} e^{i\mathbf{k} \cdot \mathbf{x}} \bar{H}_{\mathbf{x}}, \quad (2.30)$$

$$\hat{V}_{\mathbf{k}} := a^2 \sum_{\mathbf{x} \in a\mathbb{Z}_M^2} e^{i\mathbf{k} \cdot \mathbf{x}} V_{\mathbf{x}}, \quad \hat{\bar{V}}_{\mathbf{k}} := a^2 \sum_{\mathbf{x} \in a\mathbb{Z}_M^2} e^{i\mathbf{k} \cdot \mathbf{x}} \bar{V}_{\mathbf{x}}, \quad (2.31)$$

where, if $\boldsymbol{\alpha} = (\alpha_1, \alpha_2)$, then $\mathbf{k} \in \mathcal{D}_M^\alpha := \left\{ \frac{2\pi}{L} (\mathbf{n} + \frac{1}{2}\boldsymbol{\alpha}) : \mathbf{n} \in \mathbb{Z}^2 / M\mathbb{Z}^2 \right\}$. The

inverse transformation reads:

$$H_{\mathbf{x}} := \frac{1}{L^2} \sum_{\mathbf{k} \in \mathcal{D}_M^\alpha} e^{-i\mathbf{k} \cdot \mathbf{x}} \hat{H}_{\mathbf{k}}, \quad \bar{H}_{\mathbf{x}} := \frac{1}{L^2} \sum_{\mathbf{k} \in \mathcal{D}_M^\alpha} e^{-i\mathbf{k} \cdot \mathbf{x}} \hat{\bar{H}}_{\mathbf{k}}, \quad (2.32)$$

$$V_{\mathbf{x}} := \frac{1}{L^2} \sum_{\mathbf{k} \in \mathcal{D}_M^\alpha} e^{-i\mathbf{k} \cdot \mathbf{x}} \hat{V}_{\mathbf{k}}, \quad \bar{V}_{\mathbf{x}} := \frac{1}{L^2} \sum_{\mathbf{k} \in \mathcal{D}_M^\alpha} e^{-i\mathbf{k} \cdot \mathbf{x}} \hat{\bar{V}}_{\mathbf{k}}. \quad (2.33)$$

If $\hat{\Phi}_{\mathbf{k}}$ is the column vector with components $\hat{\bar{H}}_{\mathbf{k}}, \hat{H}_{\mathbf{k}}, \hat{\bar{V}}_{\mathbf{k}}, \hat{V}_{\mathbf{k}}$, respectively, the leading quadratic part of the action, $S_t(\Phi)$, can be rewritten in Fourier space as:

$$S_t(\Phi) = \frac{1}{L^2} \sum_{\mathbf{k} \in \mathcal{D}_M^\alpha} \hat{\Phi}_{-\mathbf{k}}^T C_{\mathbf{k}} \hat{\Phi}_{\mathbf{k}}, \quad (2.34)$$

where

$$C_{\mathbf{k}} := \frac{a^{-1}}{2} \begin{pmatrix} 0 & 1 + te^{-iak_1} & -1 & -1 \\ -1 - te^{iak_1} & 0 & 1 & -1 \\ 1 & -1 & 0 & 1 + te^{-iak_2} \\ 1 & 1 & -1 - te^{iak_2} & 0 \end{pmatrix}, \quad (2.35)$$

the inverse of which has the meaning of free propagator of the Grassmann field Φ . Note that $C_{\mathbf{k}}^{-1}$ is singular only at $\mathbf{k} = \mathbf{0}$ and $t = \sqrt{2} - 1$ (criticality condition). In this case, $C_{\mathbf{0}}$ has two vanishing eigenvalues and two purely imaginary eigenvalues $\pm ia^{-1}\sqrt{2}$, and the corresponding eigenmodes read:

$$\begin{pmatrix} \hat{\psi}'_{\mathbf{0},+} \\ \hat{\psi}'_{\mathbf{0},-} \\ \hat{\chi}'_{\mathbf{0},+} \\ \hat{\chi}'_{\mathbf{0},-} \end{pmatrix} = U \hat{\Phi}_{\mathbf{0}}, \quad U = \frac{1}{2} \begin{pmatrix} e^{i\frac{\pi}{4}} & e^{-i\frac{\pi}{4}} & 1 & -i \\ e^{-i\frac{\pi}{4}} & e^{i\frac{\pi}{4}} & 1 & i \\ -e^{i\frac{\pi}{4}} & -e^{-i\frac{\pi}{4}} & 1 & -i \\ -e^{-i\frac{\pi}{4}} & -e^{i\frac{\pi}{4}} & 1 & i \end{pmatrix}. \quad (2.36)$$

The natural variables at the critical point are the ‘‘critical eigenmodes’’ defined by the unitary transformation U in Eq.(2.36), namely

$$\begin{pmatrix} \hat{\psi}'_{\mathbf{k},+} \\ \hat{\psi}'_{\mathbf{k},-} \\ \hat{\chi}'_{\mathbf{k},+} \\ \hat{\chi}'_{\mathbf{k},-} \end{pmatrix} = U \hat{\Phi}_{\mathbf{k}}. \quad (2.37)$$

For later convenience, we rescale these variables as (where $\omega = \pm$)

$$\hat{\psi}'_{\mathbf{k},\omega} = \frac{i\omega}{\sqrt{\pi t}} \hat{\psi}_{\mathbf{k},\omega}, \quad \hat{\chi}'_{\mathbf{k},\omega} = \frac{i\omega}{\sqrt{\pi t}} \hat{\chi}_{\mathbf{k},\omega}, \quad (2.38)$$

so that, defining $\hat{\psi}_{\mathbf{k}}$ (resp. $\hat{\chi}_{\mathbf{k}}$) as the column vector with components $\hat{\psi}_{\mathbf{k},+}, \hat{\psi}_{\mathbf{k},-}$ (resp. $\hat{\chi}_{\mathbf{k},+}, \hat{\chi}_{\mathbf{k},-}$), we can rewrite:

$$S_t(\Phi) = -\frac{1}{4\pi L^2} \sum_{\mathbf{k} \in \mathcal{D}_M^\alpha} \left(\hat{\psi}_{-\mathbf{k}}^T C_\psi(\mathbf{k}) \hat{\psi}_{\mathbf{k}} + \hat{\chi}_{-\mathbf{k}}^T C_\chi(\mathbf{k}) \hat{\chi}_{\mathbf{k}} \right) + Q(\psi, \chi), \quad (2.39)$$

where, if $\# = \psi, \chi$:

$$C_\#(\mathbf{k}) = \begin{pmatrix} a^{-1}(-i \sin ak_1 + \sin ak_2) & i\sigma_\#(\mathbf{k}) \\ -i\sigma_\#(\mathbf{k}) & a^{-1}(-i \sin ak_1 - \sin ak_2) \end{pmatrix} \quad (2.40)$$

and

$$\sigma_\psi(\mathbf{k}) = \frac{1}{a} \left(\cos ak_1 + \cos ak_2 - 2 \frac{\sqrt{2}-1}{t} \right), \quad (2.41)$$

$$\sigma_\chi(\mathbf{k}) = \frac{1}{a} \left(\cos ak_1 + \cos ak_2 + 2 \frac{\sqrt{2}+1}{t} \right). \quad (2.42)$$

Moreover,

$$Q(\psi, \chi) = \frac{1}{4\pi L^2} \sum_{\mathbf{k} \in \mathcal{D}_M^\alpha} \left(\hat{\psi}_{-\mathbf{k}}^T Q(\mathbf{k}) \hat{\chi}_{\mathbf{k}} + \hat{\chi}_{-\mathbf{k}}^T Q(\mathbf{k}) \hat{\psi}_{\mathbf{k}} \right), \quad (2.43)$$

$$Q(\mathbf{k}) = \begin{pmatrix} a^{-1}(-i \sin ak_1 - \sin ak_2) & a^{-1}(i \cos ak_1 - i \cos ak_2) \\ a^{-1}(-i \cos ak_1 + i \cos ak_2) & a^{-1}(-i \sin ak_1 + \sin ak_2) \end{pmatrix}.$$

In terms of this notation, we can rewrite Eq.(2.2) as

$$\Xi(\mathbf{A}) = \sum_{\alpha \in \{\pm\}^2} C_{M,\alpha} \int P_\alpha(d\psi) P_\alpha(d\chi) e^{Q(\psi,\chi) + \mathcal{B}(\psi,\chi,\mathbf{A}) + \mathcal{V}(\psi,\chi,\mathbf{A})}, \quad (2.44)$$

where:

- The normalization constant $C_{M,\alpha}$ is defined as

$$C_{M,\alpha} = \frac{C_M}{2} (a^2 M)^{4M^2} \tau_\alpha \mathcal{N}_{\psi,\alpha} \mathcal{N}_{\chi,\alpha},$$

where: C_M was defined in Eq.(2.3); the factor $(a^2 M)^{4M^2}$ takes into account the change of variable from the set of Grassmann variables $\{\bar{H}_{\mathbf{x}}, H_{\mathbf{x}}, \bar{V}_{\mathbf{x}}, V_{\mathbf{x}}\}$ to $\{\hat{\psi}_{\mathbf{k},\omega}, \hat{\chi}_{\mathbf{k},\omega}\}$: in fact a computation shows that

$$\int \mathcal{D}\Phi \left[\prod_{\mathbf{k} \in \mathcal{D}_M^\alpha} \hat{H}_{\mathbf{k}} \hat{H}_{\mathbf{k}} \hat{V}_{\mathbf{k}} \hat{V}_{\mathbf{k}} \right] = a^{8M^2} [\det_{\mathbf{k},\mathbf{x}}(e^{i\mathbf{k}\cdot\mathbf{x}})]^4 = (a^2 M)^{4M^2};$$

τ_α was defined after Eq.(1.17); $\mathcal{N}_{\psi,\alpha}$ and $\mathcal{N}_{\chi,\alpha}$ are the normalization constants of the two Grassmann gaussian integrations $P_\alpha(d\psi)$ and $P_\alpha(d\chi)$, see next item.

- The Grassmann gaussian integrations $P_{\alpha}(d\psi)$, $P_{\alpha}(d\chi)$ are defined as

$$P_{\alpha}(d\psi) := \frac{1}{\mathcal{N}_{\psi,\alpha}} \left[\prod_{\mathbf{k} \in \mathcal{D}_M^{\alpha}} \prod_{\omega=\pm} d\hat{\psi}_{\mathbf{k},\omega} \right] \exp \left\{ -\frac{1}{4\pi L^2} \sum_{\mathbf{k} \in \mathcal{D}_M^{\alpha}} \hat{\psi}_{-\mathbf{k}}^T C_{\psi}(\mathbf{k}) \hat{\psi}_{\mathbf{k}} \right\},$$

$$P_{\alpha}(d\chi) := \frac{1}{\mathcal{N}_{\chi,\alpha}} \left[\prod_{\mathbf{k} \in \mathcal{D}_M^{\alpha}} \prod_{\omega=\pm} d\hat{\chi}_{\mathbf{k},\omega} \right] \exp \left\{ -\frac{1}{4\pi L^2} \sum_{\mathbf{k} \in \mathcal{D}_M^{\alpha}} \hat{\chi}_{-\mathbf{k}}^T C_{\chi}(\mathbf{k}) \hat{\chi}_{\mathbf{k}} \right\},$$

and $\mathcal{N}_{\psi,\alpha}, \mathcal{N}_{\chi,\alpha}$ are two normalization constants, fixed in such a way that $\int P_{\alpha}(d\psi) = \int P_{\alpha}(d\chi) = 1$.

- The source term $\mathcal{B}(\psi, \chi, \mathbf{A})$ is the rewriting of $(1-t^2)(\mathbf{E}, \mathbf{A})$ in terms of the new variables, namely

$$\mathcal{B}(\psi, \chi, \mathbf{A}) = -i \frac{1-t^2}{2t} \int \frac{d\mathbf{x}}{2\pi}. \quad (2.45)$$

$$\left[A_{\mathbf{x},1}(\psi_{\mathbf{x},+} - i\psi_{\mathbf{x},-} - \chi_{\mathbf{x},+} + i\chi_{\mathbf{x},-}) \tau_1(-i\psi_{\mathbf{x},+} + \psi_{\mathbf{x},-} + i\chi_{\mathbf{x},+} - \chi_{\mathbf{x},-}) \right. \\ \left. + A_{\mathbf{x},2}(\psi_{\mathbf{x},+} - \psi_{\mathbf{x},-} + \chi_{\mathbf{x},+} - \chi_{\mathbf{x},-}) \tau_2(\psi_{\mathbf{x},+} + \psi_{\mathbf{x},-} + \chi_{\mathbf{x},+} + \chi_{\mathbf{x},-}) \right],$$

where τ_j is the translation operator that shifts by one lattice step the argument of the field which it acts on: $\tau_j \psi_{\mathbf{x},\omega} = \psi_{\mathbf{x}+a\hat{\mathbf{e}}_j,\omega}$ and similarly for χ .

- $\mathcal{V}(\psi, \chi, \mathbf{A})$ is the rewriting of $\mathcal{V}(\Phi, \mathbf{A})$ in terms of the new variables. It is easy to check that its kernels satisfy the same decay estimates as those of $\mathcal{V}(\Phi, \mathbf{A})$, see Eq.(2.6) in Proposition 1.

As mentioned in the introduction, we are concerned with a scaling limit such that we take the thermodynamic limit $M \rightarrow \infty$ first, keeping $\beta = \beta(a) \neq \beta_c(\lambda)$, and then (simultaneously) $a \rightarrow 0$ and $\beta \rightarrow \beta_c(\lambda)$. In doing so, the resulting multi-point energy correlations are insensitive to the Grassmann boundary conditions, labeled by the four possible values of α ; this is true both in the $\lambda = 0$ and in the $\lambda \neq 0$ case, see [41, Appendix G]. Therefore, the multi-point energy correlation functions in the specific scaling limit that we consider are the same as those computed from the following generating function:

$$\Xi_{-,-}(\mathbf{A}) = \int P(d\psi) P(d\chi) e^{Q(\psi,\chi) + \mathcal{B}(\psi,\chi,\mathbf{A}) + \mathcal{V}(\psi,\chi,\mathbf{A})}, \quad (2.46)$$

where $P(d\psi)$ is a shorthand for $P_{-,-}(d\psi)$ and similarly for $P(d\chi)$. For future reference, let us note that the propagator of the ψ and χ fields associated

with the gaussian integrations $P(d\psi)$ and $P(d\chi)$ are given by, if $D_a^\pm(\mathbf{k}) = a^{-1}(i \sin ak_1 \pm \sin ak_2)$ and $|D_a(\mathbf{k})|^2 = -D_a^+(\mathbf{k})D_a^-(\mathbf{k})$,

$$\begin{aligned} g_{\omega,\omega'}^\psi(\mathbf{x} - \mathbf{y}) &= \int P(d\psi) \psi_{\mathbf{x},\omega} \psi_{\mathbf{y},\omega'} \\ &= \frac{2\pi}{L^2} \sum_{\mathbf{k} \in \mathcal{D}_M} \frac{e^{-i\mathbf{k}(\mathbf{x}-\mathbf{y})}}{|D_a(\mathbf{k})|^2 + [\sigma_\psi(\mathbf{k})]^2} \begin{pmatrix} D_a^+(\mathbf{k}) & i\sigma_\psi(\mathbf{k}) \\ -i\sigma_\psi(\mathbf{k}) & D_a^-(\mathbf{k}) \end{pmatrix}_{\omega,\omega'} \end{aligned} \quad (2.47)$$

and

$$\begin{aligned} g_{\omega,\omega'}^\chi(\mathbf{x} - \mathbf{y}) &= \int P(d\chi) \chi_{\mathbf{x},\omega} \chi_{\mathbf{y},\omega'} \\ &= \frac{2\pi}{L^2} \sum_{\mathbf{k} \in \mathcal{D}_M} \frac{e^{-i\mathbf{k}(\mathbf{x}-\mathbf{y})}}{|D_a(\mathbf{k})|^2 + [\sigma_\chi(\mathbf{k})]^2} \begin{pmatrix} D_a^+(\mathbf{k}) & i\sigma_\chi(\mathbf{k}) \\ -i\sigma_\chi(\mathbf{k}) & D_a^-(\mathbf{k}) \end{pmatrix}_{\omega,\omega'} \end{aligned} \quad (2.48)$$

where \mathcal{D}_M is a shorthand for $\mathcal{D}_M^{\bar{-}\bar{-}}$.

Remark. We define the *unperturbed scaling limit* as follows. Let $\beta(a)$ be fixed in such a way that, if $t = t(a) = \tanh(\beta(a)J)$ and $t_c(0) = \sqrt{2} - 1$,

$$\frac{t(a) - t_c(0)}{t(a)} = \frac{a\sigma^0(a)}{2}, \quad (2.49)$$

where $\sigma^0(a) \neq 0$ for all $a \neq 0$ and $\lim_{a \rightarrow 0} \sigma^0(a) = m^*$. The limit as $a \rightarrow 0$ with $t(a)$ fixed in this way will be referred to as the unperturbed scaling limit. The explicit form of the propagator of the ψ field shows that in the unperturbed scaling limit it behaves as:

$$g^\psi(\mathbf{x}) \rightarrow \mathbf{g}^0(\mathbf{x}) := \int \frac{d\mathbf{k}}{2\pi} \frac{e^{-i\mathbf{k}\mathbf{x}}}{\mathbf{k}^2 + (m^*)^2} \begin{pmatrix} ik_1 + k_2 & im^* \\ -im^* & ik_1 - k_2 \end{pmatrix}. \quad (2.50)$$

Note that the limiting propagator $\mathbf{g}^0(\mathbf{x})$ is normalized in such a way that in the massless case, $m^* = 0$, it reduces to Eq.(1.11). In the same limit, the propagator of the χ field $g^\chi(\mathbf{x})$ tends to zero for every fixed $\mathbf{x} \in \mathbb{R}^2$; moreover, the combination $a^{-1} \int d\mathbf{x} g^\chi(\mathbf{x})$ tends to $-c_\chi \sigma_2$, where $c_\chi = \lim_{a \rightarrow 0} a\sigma_\chi(\mathbf{0}) = \frac{2}{t_c(0)}(t_c(0) + \sqrt{2} + 1)$ and $\sigma_2 = \begin{pmatrix} 0 & -i \\ i & 0 \end{pmatrix}$ is the second Pauli matrix. In this sense, as a tends to zero:

$$g^\chi(\mathbf{x}) \simeq -ac_\chi \delta(\mathbf{x}) \sigma_2, \quad (2.51)$$

where $\delta(\mathbf{x})$ is the Dirac delta function.

The quadratic coupling $Q(\psi, \chi)$ in Eq.(2.46) can be eliminated by the linear change of variables

$$\hat{\chi}_{\mathbf{k}} \rightarrow \hat{\chi}_{\mathbf{k}} + C_{\chi}^{-1}(\mathbf{k})Q(\mathbf{k})\hat{\psi}_{\mathbf{k}} , \quad (2.52)$$

which leaves $\Xi_{-, -}(\mathbf{A})$ invariant. Note that for small \mathbf{k} , the kernel $C_{\chi}^{-1}(\mathbf{k})Q(\mathbf{k})$ associated to this transformation is small, namely $C_{\chi}^{-1}(\mathbf{k})Q(\mathbf{k}) = O(a|\mathbf{k}|)$; that is, from a dimensional point of view, the action of $C_{\chi}^{-1}(\mathbf{k})Q(\mathbf{k})$ on $\hat{\psi}_{\mathbf{k}}$ is the same as the action of the differential operator $a\partial_{\mathbf{x}}$. After the transformation Eq.(2.52) we can rewrite:

$$\Xi_{-, -}(\mathbf{A}) = \frac{\overline{\mathcal{N}}_{\psi}}{\mathcal{N}_{\psi}} \int \overline{P}(d\psi)P(d\chi)e^{\overline{\mathcal{B}}(\psi, \chi, \mathbf{A}) + \overline{\mathcal{V}}(\psi, \chi, \mathbf{A})} , \quad (2.53)$$

where $\overline{\mathcal{B}}(\psi, \chi, \mathbf{A})$ and $\overline{\mathcal{V}}(\psi, \chi, \mathbf{A})$ are the rewritings of $\mathcal{B}(\psi, \chi, \mathbf{A})$ and $\mathcal{V}(\psi, \chi, \mathbf{A})$, respectively, in terms of the new variables; moreover, the gaussian integration $\overline{P}(d\psi)$ is defined as

$$\overline{P}(d\psi) = \frac{1}{\overline{\mathcal{N}}_{\psi}} \left[\prod_{\mathbf{k} \in \mathcal{D}_M} \prod_{\omega = \pm} d\hat{\psi}_{\mathbf{k}, \omega} \right] \exp \left\{ - \frac{1}{4\pi L^2} \sum_{\mathbf{k} \in \mathcal{D}_M} \hat{\psi}_{-\mathbf{k}}^T \overline{C}_{\psi}(\mathbf{k}) \hat{\psi}_{\mathbf{k}} \right\} , \quad (2.54)$$

where the normalization constant $\overline{\mathcal{N}}_{\psi}$ is chosen in such a way that $\int \overline{P}(d\psi) = 1$ and

$$\overline{C}_{\psi}(\mathbf{k}) = C_{\psi}(\mathbf{k}) - Q(\mathbf{k})C_{\chi}^{-1}(\mathbf{k})Q(\mathbf{k}). \quad (2.55)$$

Remarks.

1. It is easy to check that the change of variables Eq.(2.52) does not affect the bounds on the kernels of the effective potential; i.e., the kernels of $\overline{\mathcal{B}}$ and $\overline{\mathcal{V}}$ satisfy the same bounds as the kernels in Proposition 1, see Eq.(2.6).
2. The correction $\overline{C}_{\psi}(\mathbf{k}) - C_{\psi}(\mathbf{k})$ is small at small \mathbf{k} , i.e.,

$$Q(\mathbf{k})C_{\chi}^{-1}(\mathbf{k})Q(\mathbf{k}) = O(a|\mathbf{k}|^2) .$$

In particular, this means that the unperturbed scaling limit of the propagator $\overline{g}_{\omega, \omega'}^{\psi}(\mathbf{x}) = \int \overline{P}(d\psi) \psi_{\mathbf{x}, \omega} \psi_{0, \omega'}$, in the sense of the remark after Eq.(2.48), is the same as the one of $g^{\psi}(\mathbf{x})$, that is, it is equal to $\mathbf{g}^0(\mathbf{x})$.

3. The representation Eq.(2.53) is valid also when $\lambda = 0$, in which case $\overline{\mathcal{V}} = 0$ and the scaling limit of the energy-energy correlations can be

computed explicitly. In fact, using the explicit forms of $\mathcal{B}(\psi, \chi, \mathbf{A})$ in Eq.(2.45), of the linear transformation Eq.(2.52) and of the gaussian integrations $\overline{P}(d\psi)P(d\chi)$, we find that for all m -tuples of distinct points $\mathbf{x}_1, \dots, \mathbf{x}_m$, $m \geq 2$ the unperturbed scaling limit (in the sense of the remark after Eq.(2.48)) of the energy correlations is:

$$\begin{aligned} & \lim_{a \rightarrow 0} \lim_{L \rightarrow \infty} \langle \varepsilon_{\mathbf{x}_1, j_1}; \dots; \varepsilon_{\mathbf{x}_m, j_m} \rangle_{\beta(a), L}^T = \\ & = \lim_{a \rightarrow 0} \lim_{L \rightarrow \infty} a^{-2m} \frac{\partial^m}{\partial A_{\mathbf{x}_1, j_1} \dots \partial A_{\mathbf{x}_m, j_m}} \Xi_{-, -}(\mathbf{A}) \Big|_{\mathbf{A}=\mathbf{0}} = \quad (2.56) \\ & = \left(\frac{-i}{\pi} \right)^m \mathcal{E}_{\mathfrak{g}^0}^T(\psi_{\mathbf{x}_1, +} \psi_{\mathbf{x}_1, -}; \dots; \psi_{\mathbf{x}_m, +} \psi_{\mathbf{x}_m, -}), \end{aligned}$$

where in the last line $\mathcal{E}_{\mathfrak{g}^0}^T$ indicates the truncated expectation with respect to the gaussian fermionic integration $P_{\mathfrak{g}^0}(d\psi)$ with propagator \mathfrak{g}^0 ; i.e., given n functions X_1, \dots, X_n of the Grassmann variables ψ :

$$\mathcal{E}_{\mathfrak{g}^0}^T(X_1; \dots; X_n) = \frac{\partial^n}{\partial \lambda_1 \dots \partial \lambda_n} \log \int P_{\mathfrak{g}^0}(d\psi) e^{\lambda_1 X_1 + \dots + \lambda_n X_n} \Big|_{\lambda_i=0}, \quad (2.57)$$

and a similar definition is valid for a more general gaussian fermionic integration. In the last line of Eq.(2.56), one may think of $(-i/\pi)\psi_{\mathbf{x}, +}\psi_{\mathbf{x}, -}$ as the scaling limit of the Grassmann operator coupled to $A_{\mathbf{x}, j}$ in the source term $\overline{\mathcal{B}}$, that is $E_{\mathbf{x}, j}$ written in terms of ψ, χ . From its definition, see Eq.(2.45), it is apparent that, for every finite a , such Grassmann operator also includes terms of the form $\chi_{\mathbf{x}, +}\chi_{\mathbf{x}, -}$ or $\psi_{\mathbf{x}, \omega} a \partial_{\mathbf{x}} \psi_{\mathbf{x}, \omega}$: however, the correlations among such bilinears at distinct points vanish in the scaling limit.

The truncated expectation in the last line of Eq.(2.56) can be graphically represented (and explicitly computed) in terms of loop diagrams; correspondingly Eq.(2.56) can be rewritten as Eq.(1.8).

2.3 The perturbed scaling limit and the temperature counterterm

The last step that is convenient to perform before setting up the multiscale analysis that we will use to compute Eq.(2.53), is to properly fix the location of the singularity of $\overline{P}(d\psi)$. Note, in fact, that the propagator associated with $\overline{P}(d\psi)$ is singular at $t = t_c(0) = \sqrt{2} - 1$ (and $\mathbf{k} = \mathbf{0}$), while we know that the location of the singularity changes in the presence of the interaction, moving to $t = t_c(\lambda) = \tanh(\beta_c(\lambda)J)$, where $\beta_c(\lambda)$ is the interacting inverse critical temperature computed in [47], which will also be derived below. Therefore,

it is convenient to rewrite the mass $\sigma_\psi(\mathbf{0})$ appearing in the propagator of the ψ field as (recalling that $t_c(0) = \sqrt{2} - 1$)

$$\sigma_\psi(\mathbf{0}) = \frac{2t - t_c(0)}{a} \frac{t - t_c(0)}{t} = \sigma + 4\pi a^{-1}\nu, \quad (2.58)$$

where the mass

$$\sigma = \sigma(a) = \frac{2t_c(0)}{a t_c(\lambda)} \frac{t - t_c(\lambda)}{t} \quad (2.59)$$

vanishes at the interacting critical point and is of order 1 with respect to a as $a \rightarrow 0$; we assume that $\sigma(a) \neq 0$ for every finite $a > 0$ and in the scaling limit $\lim_{a \rightarrow 0} \sigma(a) = m^*$, with $m^* \in \mathbb{R}$. On the other hand, the constant

$$\nu = \nu(\lambda) = \frac{t_c(\lambda) - t_c(0)}{2\pi t_c(\lambda)} \quad (2.60)$$

should be thought of as a *counterterm* that will be used below to fix the interacting critical temperature. The rewriting Eq.(2.58) induces an analogous rewriting at $\mathbf{k} \neq \mathbf{0}$, i.e., $\sigma_\psi(\mathbf{k}) = \sigma(\mathbf{k}) + 4\pi a^{-1}\nu$, with $\sigma(\mathbf{k}) = a^{-1}(\cos ak_1 + \cos ak_2 - 2) + \sigma$. Correspondingly we decompose the inverse propagator of the ψ field as $\bar{C}_\psi(\mathbf{k}) = C_\sigma(\mathbf{k}) - 4\pi a^{-1}\nu\sigma_2$, where $\sigma_2 = \begin{pmatrix} 0 & -i \\ i & 0 \end{pmatrix}$ is the second Pauli matrix and

$$C_\sigma(\mathbf{k}) = \begin{pmatrix} -D_a^-(\mathbf{k}) & i\sigma(\mathbf{k}) \\ -i\sigma(\mathbf{k}) & -D_a^+(\mathbf{k}) \end{pmatrix} - Q(\mathbf{k})C_\chi^{-1}(\mathbf{k})Q(\mathbf{k}), \quad (2.61)$$

which induces the following representation for the generating function:

$$\Xi_{-,-}(\mathbf{A}) = \mathcal{N}_\sigma \int P_\sigma(d\psi)P(d\chi)e^{\bar{\mathcal{B}}(\psi,\chi,\mathbf{A}) + \bar{\mathcal{V}}(\psi,\chi,\mathbf{A}) + a^{-1}\nu \int d\mathbf{x} \psi_{\mathbf{x}}\sigma_2\psi_{\mathbf{x}}}, \quad (2.62)$$

where $P_\sigma(d\psi)$ is the (normalized) gaussian integration associated to the matrix C_σ and \mathcal{N}_σ is a suitable normalization constant. Eq.(2.62) will be the starting point for the multiscale analysis discussed below. But before that, let us discuss a few relevant symmetry properties of the fermionic action.

2.4 Symmetries in the Grassman representation

The integration $\prod_{\mathbf{k},\omega} d\hat{\psi}_{\mathbf{k},\omega} d\hat{\chi}_{\mathbf{k},\omega}$, the quadratic contributions to the Grassmann action $-(4\pi L^2)^{-1} \sum_{\mathbf{k} \in \mathcal{D}_M^\alpha} \hat{\psi}_{-\mathbf{k}}^T C_\sigma(\mathbf{k}) \hat{\psi}_{\mathbf{k}}$ and $-(4\pi L^2)^{-1} \sum_{\mathbf{k} \in \mathcal{D}_M^\alpha} \hat{\psi}_{-\mathbf{k}}^T C_\chi(\mathbf{k}) \hat{\psi}_{\mathbf{k}}$, as well as the source and the interaction terms $\bar{\mathcal{B}}(\psi, \chi, \mathbf{A})$, $\bar{\mathcal{V}}(\psi, \chi, \mathbf{A})$ and $a^{-1}\nu \int d\mathbf{x} \psi_{\mathbf{x}}\sigma_2\psi_{\mathbf{x}}$ are each separately unchanged under any of the following substitutions (here we indicate $A_{\mathbf{x},j}$ by A_b , where b is identified with the unordered pair $b = \{\mathbf{x}, \mathbf{x} + a\hat{\mathbf{e}}_j\}$)

1. $\psi_{\mathbf{x},\omega} \rightarrow i\omega\psi_{-\mathbf{x},\omega}$, $\chi_{\mathbf{x},\omega} \rightarrow i\omega\chi_{-\mathbf{x},\omega}$, $A_b \rightarrow A_{-b}$ where, if $b = \{\mathbf{x}, \mathbf{x}'\}$, then $-b = \{-\mathbf{x}, -\mathbf{x}'\}$ (parity)
2. $\psi_{\mathbf{x},\omega} \rightarrow \omega e^{i\omega\frac{\pi}{4}}\psi_{R\mathbf{x},-\omega}$, $\chi_{\mathbf{x},\omega} \rightarrow -\omega e^{i\omega\frac{\pi}{4}}\chi_{R\mathbf{x},-\omega}$, $A_b \rightarrow A_{Rb}$ with $R(x_1, x_2) = (-x_2, -x_1)$ and $Rb = R\{\mathbf{x}, \mathbf{x}'\} = \{R\mathbf{x}, R\mathbf{x}'\}$ (diagonal reflection)
3. $\psi_{\mathbf{x},\omega} \rightarrow i\psi_{F\mathbf{x},-\omega}$, $\chi_{\mathbf{x},\omega} \rightarrow i\chi_{F\mathbf{x},-\omega}$, $A_b \rightarrow A_{Fb}$ with $F(x_1, x_2) = (-x_1, x_2)$ and $Fb = F\{\mathbf{x}, \mathbf{x}'\} = \{F\mathbf{x}, F\mathbf{x}'\}$ (orthogonal reflection)
4. $\psi_{\mathbf{x},\omega} \rightarrow \psi_{\mathbf{x},-\omega}$, $\chi_{\mathbf{x},\omega} \rightarrow \chi_{\mathbf{x},-\omega}$, $c \rightarrow c^*$, $A_b \rightarrow A_b$ for all complex coefficients (complex conjugation)

The invariance of the integration is only a matter of checking that the correct sign is produced, as indeed it is.

To check the invariance of the quadratic terms, we consider the most general possible form which will be invariant under these transformations, as this will be helpful in the further analysis. A general quadratic form in the ψ fields is

$$\sum_{\mathbf{k} \in \mathcal{D}_M} \hat{\psi}_{-\mathbf{k}}^T C(\mathbf{k}) \hat{\psi}_{\mathbf{k}} = \sum_{\mathbf{k} \in \mathcal{D}_M} \hat{\psi}_{-\mathbf{k}}^T \begin{pmatrix} a(\mathbf{k}) & b(\mathbf{k}) \\ c(\mathbf{k}) & d(\mathbf{k}) \end{pmatrix} \hat{\psi}_{\mathbf{k}} \quad (2.63)$$

with $C(\mathbf{k}) = -C^T(-\mathbf{k})$, that is $a(\mathbf{k}) = -a(-\mathbf{k})$, $d(\mathbf{k}) = -d(-\mathbf{k})$ and $b(\mathbf{k}) = -c(-\mathbf{k})$. This matrix transforms respectively as

1.
$$\begin{pmatrix} a(\mathbf{k}) & b(\mathbf{k}) \\ c(\mathbf{k}) & d(\mathbf{k}) \end{pmatrix} \rightarrow \begin{pmatrix} a(\mathbf{k}) & -c(\mathbf{k}) \\ -b(\mathbf{k}) & d(\mathbf{k}) \end{pmatrix} \quad (2.64)$$

2.
$$\begin{pmatrix} a(\mathbf{k}) & b(\mathbf{k}) \\ c(\mathbf{k}) & d(\mathbf{k}) \end{pmatrix} \rightarrow \begin{pmatrix} -id(R\mathbf{k}) & -c(R\mathbf{k}) \\ -b(R\mathbf{k}) & ia(R\mathbf{k}) \end{pmatrix} \quad (2.65)$$

3.
$$\begin{pmatrix} a(\mathbf{k}) & b(\mathbf{k}) \\ c(\mathbf{k}) & d(\mathbf{k}) \end{pmatrix} \rightarrow \begin{pmatrix} -d(F\mathbf{k}) & -c(F\mathbf{k}) \\ -b(F\mathbf{k}) & -a(F\mathbf{k}) \end{pmatrix} \quad (2.66)$$

4.
$$\begin{pmatrix} a(\mathbf{k}) & b(\mathbf{k}) \\ c(\mathbf{k}) & d(\mathbf{k}) \end{pmatrix} \rightarrow \begin{pmatrix} d^*(-\mathbf{k}) & c^*(-\mathbf{k}) \\ b^*(-\mathbf{k}) & a^*(-\mathbf{k}) \end{pmatrix} \quad (2.67)$$

Therefore, the quadratic form is invariant under these symmetries iff $a(\mathbf{k}) = -a(-\mathbf{k}) = -id(R\mathbf{k}) = -d(F\mathbf{k}) = -d^*(\mathbf{k})$ and $b(\mathbf{k}) = b(-\mathbf{k}) = -c(\mathbf{k}) = b(R\mathbf{k}) = b(F\mathbf{k}) = -b^*(\mathbf{k})$. Exactly the same is true of a quadratic term in χ . We note that $C_\sigma(\mathbf{k})$ and $C_\chi(\mathbf{k})$ as expressed in Eqs.(2.61) and (2.40), as well as the counterterm $a^{-1}\nu \int d\mathbf{x} \psi_{\mathbf{x}} \sigma_2 \psi_{\mathbf{x}}$, are indeed invariant under these

transformation. In passing, let us note that any quadratic form compatible with these symmetries is given to first order in \mathbf{k} by

$$Z \begin{pmatrix} D_a^-(\mathbf{k}) & -i\sigma \\ i\sigma & D_a^+(\mathbf{k}) \end{pmatrix} \quad (2.68)$$

with Z and σ two *real* parameters.

To examine the effect on $\bar{\mathcal{V}}$, we note that the energy density E_b (which is the Grassmann bilinear coupled to A_b in the source term $\bar{\mathcal{B}}(\psi, \chi, \mathbf{A})$) is covariant under the four symmetries above: $E_b \xrightarrow{(1)} E_{-b}$, $E_b \xrightarrow{(2)} E_{Rb}$, $E_b \xrightarrow{(3)} E_{Fb}$, $E_b \xrightarrow{(4)} E_b$. This suffices to show that the source term $\bar{\mathcal{B}}$ is invariant under these transformations; furthermore we note that $\bar{\mathcal{V}}$ is given as a polynomial in the E_b and A_b with real coefficients, symmetric under parity, diagonal reflections and orthogonal reflections, as follows from the construction in Sec.2.1, and therefore is also invariant.

3 Multiscale integration

We now want to compute $\Xi_{-,-}(\mathbf{A})$ as expressed by Eq.(2.62). The strategy is to integrate the Grassmann functional integral step by step, in an inductive fashion. The outcome is a multiscale expansion that has been described in great detail in several papers, see e.g. [25, 26, 42] for some recent reviews. A self-contained presentation is also described below. From now on C, C', c, c', \dots , indicate universal positive constants, whose specific values may change from line to line.

3.1 The integration of the χ field

The first step simply consists in integrating out the χ field, after which we rewrite:

$$\Xi_{-,-}(\mathbf{A}) = e^{|\Lambda|\tilde{F}_N + \mathcal{S}^{(N)}(\mathbf{A})} \int P_\sigma(d\psi) e^{\tilde{\mathcal{V}}^{(N)}(\psi, \mathbf{A}) + \mathcal{B}^{(N)}(\psi, \mathbf{A}) + a^{-1}\nu \int d\mathbf{x} \psi_{\mathbf{x}} \sigma_2 \psi_{\mathbf{x}}}, \quad (3.1)$$

where Λ is a shorthand for Λ_L^a and

$$e^{|\Lambda|\tilde{F}_N + \mathcal{S}^{(N)}(\mathbf{A}) + \tilde{\mathcal{V}}^{(N)}(\psi, \mathbf{A}) + \mathcal{B}^{(N)}(\psi, \mathbf{A})} = \mathcal{N}_\sigma \int P(d\chi) e^{\bar{\mathcal{V}}(\psi, \chi, \mathbf{A}) + \bar{\mathcal{B}}(\psi, \chi, \mathbf{A})}. \quad (3.2)$$

Recall that the label N indicates the scale of the lattice spacing, which is equal to $a = \ell_0 2^{-N}$, with ℓ_0 the unit macroscopic length (which will be set

equal to 1 in the following). The *effective potential* $\tilde{\mathcal{V}}^{(N)}$ on scale N can be computed in terms of truncated expectations, namely

$$|\Lambda| \tilde{F}_N - \log \mathcal{N}_\sigma + \mathcal{S}^{(N)}(\mathbf{A}) + \tilde{\mathcal{V}}^{(N)}(\psi, \mathbf{A}) + \mathcal{B}^{(N)}(\psi, \mathbf{A}) = \quad (3.3)$$

$$+ \sum_{s \geq 1} \frac{1}{s!} \mathcal{E}_\chi^T \underbrace{(\bar{\mathcal{V}}(\psi, \chi, \mathbf{A}) + \bar{\mathcal{B}}(\psi, \chi, \mathbf{A}); \cdots; \bar{\mathcal{V}}(\psi, \chi, \mathbf{A}) + \bar{\mathcal{B}}(\psi, \chi, \mathbf{A}))}_{s \text{ times}}$$

where \mathcal{E}_χ^T is defined in way analogous to Eq.(2.57), with $P_{g^0}(d\psi)$ replaced by $P(d\chi)$. The normalization constant \tilde{F}_N in the left hand side is defined in such a way that $\mathcal{S}^{(N)}(0) = \tilde{\mathcal{V}}^{(N)}(0, \mathbf{A}) = 0$, while $\mathcal{B}^{(N)}(\psi, \mathbf{A})$ collects the contributions that are quadratic in ψ and linear in \mathbf{A} . Note that \mathcal{E}_χ^T is a multilinear operator of its arguments, so that each term in the r.h.s. can be computed by expanding $\bar{\mathcal{V}}(\psi, \chi, \mathbf{A}) + \bar{\mathcal{B}}(\psi, \chi, \mathbf{A})$ into monomials in χ and then by acting with \mathcal{E}_χ^T on each monomial separately. The second line of Eq.(3.3) can be conveniently represented graphically as in Fig.6. The tree in

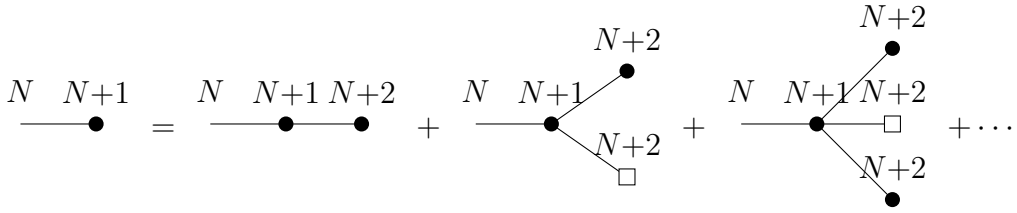

Figure 6: The graphical representation of the second line of Eq.(3.3).

the l.h.s., consisting of a single horizontal branch, connecting the left node (called the *root* and associated to the *scale label* N) with a black dot on scale $N + 1$, represents the l.h.s. of Eq.(3.3). In the r.h.s., the sum of all the terms with s final points represents the term of order s in the r.h.s. of Eq.(3.3): a scale label N is attached to the leftmost node (the root); a scale label $N + 1$ is attached to the central node (corresponding to the action of \mathcal{E}_χ^T , where χ is thought of as the “field on scale $N+1$ ”); a scale label $N+2$ is attached to the s rightmost nodes (“endpoints”), which can be either “normal”, in which case we draw them as black dots and associate them with $\bar{\mathcal{V}}$, or “special”, in which case we draw them as open squares and associate them with $\bar{\mathcal{B}}$. We denote by $\mathcal{T}_{N;n,m}^{(N)}$ the set of trees with n normal and m special endpoints. Moreover, we denote the central node by v_0 and the endpoints by v_1, \dots, v_s ; there is a natural partial ordering on the trees from left to right, and we shall denote this ordering by $v_0 < v_i$. The $\bar{\mathcal{V}}$ and $\bar{\mathcal{B}}$ associated with the endpoints consist of a sum of several different field monomials, which can be distinguished by assigning sets P_{v_i} of field labels f . Each field label consist of

a specification of the field type (either A , or ψ , or χ), and of the ω indices of the Grassmann fields and the j indices of the A fields. We shall also denote by P_{v_0} the set of field labels associated to the A and ψ fields, which can be thought of as the fields that survive the integration $P(d\chi)$. Finally, given a tree $\tau \in \mathcal{T}_{N;n,m}^{(N)}$ and the sets P_{v_0}, \dots, P_{v_s} , let $\mathbf{P} = \{P_{v_0}, \dots, P_{v_s}\}$ and let \mathcal{P}_τ be the set spanned by \mathbf{P} , so that the r.h.s. of Eq.(3.3) can be rewritten as

$$\sum_{\substack{n,m \geq 0 \\ n+m \geq 1}} \sum_{\tau \in \mathcal{T}_{N;n,m}^{(N)}} \mathcal{V}^{(N)}(\tau, \psi, \mathbf{A}), \quad \mathcal{V}^{(N)}(\tau, \psi, \mathbf{A}) = \sum_{\mathbf{P} \in \mathcal{P}_\tau} \mathcal{V}^{(N)}(\tau, \mathbf{P}),$$

$$\mathcal{V}^{(N)}(\tau, \mathbf{P}) = \sum_{\omega_{v_0}} \int d\mathbf{x}_{v_0} \psi_{P_{v_0}^\psi} A_{P_{v_0}^A} K_{\tau, \mathbf{P}}^{(N)}(\mathbf{x}_{v_0}), \quad (3.4)$$

where $\mathbf{x}_v = \cup_{w \geq v} \cup_{f \in P_w} \{\mathbf{x}(f)\}$, $\omega_v = \cup_{w \geq v} \cup_{f \in P_w} \{\omega(f)\}$, and, if $P_{v_0}^\psi$ and $P_{v_0}^A$ are the subsets of P_{v_0} collecting the fields of type ψ and A , respectively,

$$\psi_{P_{v_0}^\psi} = \prod_{f \in P_{v_0}^\psi} \psi_{\mathbf{x}(f), \omega(f)}, \quad A_{P_{v_0}^A} = \prod_{f \in P_{v_0}^A} A_{\mathbf{x}(f), j(f)}. \quad (3.5)$$

Moreover, if $Q_{v_i} = P_{v_0} \cap P_{v_i}$, noting that $P_{v_i} \setminus Q_{v_i} = P_{v_i}^\chi$,

$$K_{\tau, \mathbf{P}}^{(N)}(\mathbf{x}_{v_0}) = \frac{1}{s!} \prod_{i=1}^s K_{v_i}^{(N+1)}(\mathbf{x}_{v_i}) \mathcal{E}_\chi^T(\chi_{P_{v_1}^\chi}; \dots; \chi_{P_{v_s}^\chi}), \quad (3.6)$$

where $\chi_{P_{v_i}^\chi}$ has a definition similar to Eq.(3.5) and $K_{v_i}^{(N+1)}(\mathbf{x}_{v_i})$ is the kernel of the monomial labeled by P_{v_i} , whose decay properties follow from Proposition 1.

The action of the truncated expectation in the r.h.s. of Eq.(3.6) can be computed in terms of a tree interpolation formula, originally due to Battle, Brydges and Federbush [3, 12, 13] and re-derived in several review papers, see e.g. [25, 26]:

$$\mathcal{E}_\chi^T(\chi_{P_{v_1}^\chi}; \dots; \chi_{P_{v_s}^\chi}) = \sum_{T \in \mathbf{T}} \alpha_T \prod_{\ell \in T} g_\ell^{(N+1)} \int P_T(\mathbf{t}) \text{Pf } G^{N+1, T}(\mathbf{t}), \quad (3.7)$$

where:

- the first sum runs over set of lines forming a *spanning tree* between the “boxes” or “clusters” v_1, \dots, v_s , i.e., T is a set of lines that becomes a tree if one identifies all the points in the same clusters;
- α_T is a sign (irrelevant for the subsequent bounds);

- $g_\ell^{(N+1)}$ is a shorthand for $g_{\omega(\ell),\omega'(\ell)}^{\mathbf{x}}(\mathbf{x}(\ell) - \mathbf{x}'(\ell))$, where $\omega(\ell), \omega'(\ell)$ and $\mathbf{x}(\ell), \mathbf{x}'(\ell)$ are the ω and \mathbf{x} indices associated to the two ends of the line ℓ , which should be thought as being obtained from the pairing (contraction) of two fields $\chi_{\mathbf{x}(\ell),\omega(\ell)}$ and $\chi_{\mathbf{x}'(\ell),\omega'(\ell)}$;
- if $\mathbf{t} = \{t_{i,i'} \in [0, 1], 1 \leq i, i' \leq s\}$, then $dP_T(\mathbf{t})$ is a probability measure with support on a set of \mathbf{t} such that $t_{i,i'} = \mathbf{u}_i \cdot \mathbf{u}_{i'}$ for some family of vectors $\mathbf{u}_i \in \mathbb{R}^s$ of unit norm;
- if $2p = \sum_{i=1}^s |P_{v_i}^{\mathbf{x}}|$, then $G^{N+1,T}(\mathbf{t})$ is an antisymmetric $(2p - 2s + 2) \times (2p - 2s + 2)$ matrix, whose elements are given by $G_{f,f'}^{N+1,T} = t_{i(f),i(f')} g_{\ell(f,f')}^{(N+1)}$, where: $f, f' \notin \cup_{\ell \in T} \{f_\ell^1, f_\ell^2\}$ and f_ℓ^1, f_ℓ^2 are the two field labels associated to the two (entering and exiting) half-lines contracted into ℓ ; $i(f) \in \{1, \dots, s\}$ is s.t. $f \in P_{v_{i(f)}}$; $g_{\ell(f,f')}^{(N+1)}$ is the propagator associated to the line obtained by contracting the two half-lines with indices f and f' ;
- $\text{Pf } G^{N+1,T}$ is the *Pfaffian* of $G^{N+1,T}$; given an antisymmetric matrix $G_{ij} = -G_{ji}$, $i, j = 1, \dots, 2k$, its Pfaffian is defined as

$$\begin{aligned} \text{Pf } G &= \frac{1}{2^k k!} \sum_{\pi} (-1)^\pi G_{\pi(1)\pi(2)} \cdots G_{\pi(2k-1)\pi(2k)} \\ &= \int d\chi_1 \cdots d\chi_{2k} e^{-\frac{1}{2} \sum_{i,j} \chi_i G_{ij} \chi_j}, \end{aligned} \quad (3.8)$$

where in the first line π is a permutation of $\{1, \dots, 2k\}$ and $(-1)^\pi$ is its parity while, in the second line, χ_1, \dots, χ_{2k} are Grassmanian variables. A well known property is that $(\text{Pf } G)^2 = \det G$.

If $s = 1$ the sum over T is empty, but we can still use the Eq.(3.7) by interpreting the r.h.s. as equal to 0 if P_1 is empty and equal to $\text{Pf } G^{N+1,T}(\mathbf{1})$ otherwise. Note that if the Pfaffian is expanded by using Eq.(3.8), then Eq.(3.7) reduces to the usual representation of the truncated expectation in terms of connected Feynman diagrams. The spanning trees in Eq.(3.7) guarantee the minimal connection among the clusters of fields v_1, \dots, v_s and the Pfaffian can be thought of as a resummation of all the Feynman diagrams obtained by pairing (contracting) in all possible ways the fields χ outside the spanning tree, with the rule that each contracted pair $(\chi_{\mathbf{x},\omega}, \chi_{\mathbf{y},\omega'})$ is replaced by $g_{\omega,\omega'}^{\mathbf{x}}(\mathbf{x} - \mathbf{y})$; the interpolation in \mathbf{t} is necessary in order to avoid overcounting of the diagrams.

The reason why we prefer to use the Pfaffian expansion rather than the more usual expansion in connected Feynman diagrams is that the former is

better behaved from a combinatorial point of view: using the fact that the number of spanning trees in the sum \sum_T in the r.h.s. of Eq.(3.7) is bounded by $s!C^{2p}$, where $2p = \sum_{i=1}^s |P_{v_i}^X|$ (see, e.g., [25, Appendix A3.3] for a proof of this fact), we find that for fixed P_{v_0} the contribution to the kernel of $\psi_{P_{v_0}^\psi} A_{P_{v_0}^A}$ coming from a fixed tree $\tau \in \mathcal{T}_{N;n,m}^{(N)}$ can be bounded as:

$$\begin{aligned} & \sum_{P_{v_1}, \dots, P_{v_s}} \frac{1}{s!} \int d\mathbf{x}_{v_0} \prod_{i=1}^s |K_{v_i}^{(N+1)}(\mathbf{x}_{v_i})| \sum_{T \in \mathbf{T}} \prod_{\ell \in T} |g_\ell^{(N+1)}| \|\det G^{N+1,T}\|_\infty^{1/2} \quad (3.9) \\ & \leq \|g_\ell^{(N+1)}\|_1^{s-1} \sum_{P_{v_1}, \dots, P_{v_s}} \int d\mathbf{x}_{v_0} \prod_{i=1}^s C^{|P_{v_i}|} |K_{v_i}^{(N+1)}(\mathbf{x}_{v_i})| \cdot \|\det G^{N+1,T}\|_\infty^{1/2}, \end{aligned}$$

where $\|\det G^{N+1,T}\|_\infty^{1/2}$ indicates the square root of the L^∞ norm of the determinant w.r.t. both the position variables \mathbf{x}_{v_0} and the interpolation parameter \mathbf{t} (the square root is due to the fact that $|\text{Pf } G^{N+1,T}| = |\det G^{N+1,T}|^{1/2}$); moreover, in the second line, recalling that $g_\ell^{(N+1)}$ is a shorthand for $g_{\omega(\ell), \omega'(\ell)}^X(\mathbf{x}(\ell) - \mathbf{x}'(\ell))$,

$$\|g_\ell^{(N+1)}\|_1 = \int d\mathbf{x} \|g^X(\mathbf{x})\| \leq C2^{-N}, \quad (3.10)$$

simply because the propagator of the χ field decays exponentially on scale $a = 2^{-N}$, as it follows from its explicit expression Eq.(2.48), see also Eq.(2.51). More precisely, if $\|\cdot\|$ is the Hilbert-Schmidt norm,

$$\|g^X(\mathbf{x} - \mathbf{y})\| \leq C2^N e^{-c2^N |\mathbf{x} - \mathbf{y}|}. \quad (3.11)$$

In order to bound $\det G^T$, we use the *Gram-Hadamard inequality*, stating that, if M is a square matrix with elements M_{ij} of the form $M_{ij} = \langle A_i, B_j \rangle$, where A_i, B_j are vectors in a Hilbert space with scalar product $\langle \cdot, \cdot \rangle$, then

$$|\det M| \leq \prod_i \|B_i\| \cdot \|C_i\|. \quad (3.12)$$

where $\|\cdot\|$ is the norm induced by the scalar product. See [25, Theorem A.1] for a proof of Eq.(3.12).

Let $\mathcal{H} = \mathbb{R}^s \otimes \mathcal{H}_0$, where \mathcal{H}_0 is the Hilbert space of the functions $\mathbf{F} : \Lambda \rightarrow \mathbb{C}^2$, with scalar product $\langle \mathbf{F}, \mathbf{G} \rangle = \sum_{\omega=\pm} \int dz F_\omega^*(\mathbf{z}) G_\omega(\mathbf{z})$, where $F_\omega = [\mathbf{F}]_\omega$, $G_\omega = [\mathbf{G}]_\omega$, $\omega = \pm$, are the components of the vectors \mathbf{F} and \mathbf{G} . It is easy to verify that

$$\begin{aligned} G_{f,f'}^T &= t_{i(f), i(f')} g_{\omega(f), \omega(f')}(\mathbf{x}(f) - \mathbf{x}(f')) \\ &= \langle \mathbf{u}_{i(f)} \otimes \mathbf{B}_{\mathbf{x}(f), \omega(f)}, \mathbf{u}_{i(f')} \otimes \mathbf{C}_{\mathbf{x}(f'), \omega(f')} \rangle, \quad (3.13) \end{aligned}$$

where: $\mathbf{u}_i \in \mathbb{R}^s$, $i = 1, \dots, s$, are vectors such that $t_{i,i'} = \mathbf{u}_i \cdot \mathbf{u}_{i'}$; $\mathbf{B}_{\mathbf{x},\rho}$ and $\mathbf{C}_{\mathbf{x},\rho}$ have components:

$$\begin{aligned} [\mathbf{B}_{\mathbf{x},\omega}(\mathbf{z})]_\sigma &= \frac{(2\pi)^{1/2}}{L^2} \sum_{\mathbf{k}} \frac{e^{-i\mathbf{k}(\mathbf{z}-\mathbf{x})}}{[|D_a(\mathbf{k})|^2 + |\sigma_\chi(\mathbf{k})|^2]^{1/4}} \delta_{\omega,s}, \\ [\mathbf{C}_{\mathbf{x},\omega}(\mathbf{z})]_\sigma &= \frac{(2\pi)^{1/2}}{L^2} \sum_{\mathbf{k}} \frac{e^{-i\mathbf{k}(\mathbf{z}-\mathbf{x})}}{[|D_a(\mathbf{k})|^2 + |\sigma_\chi(\mathbf{k})|^2]^{3/4}} \begin{pmatrix} D_a^+(\mathbf{k}) & i\sigma_\chi(\mathbf{k}) \\ -i\sigma_\chi(\mathbf{k}) & D_a^-(\mathbf{k}) \end{pmatrix}_{\sigma,\omega}, \end{aligned} \quad (3.14)$$

so that

$$\|\mathbf{B}_{\mathbf{x},\omega}\|^2 = \|\mathbf{C}_{\mathbf{x},\rho}\|^2 = \frac{2\pi}{L^2} \sum_{\mathbf{k}} \frac{1}{[|D_a(\mathbf{k})|^2 + |\sigma_\chi(\mathbf{k})|^2]^{1/2}} \leq C2^N, \quad (3.15)$$

for a suitable constant C . Using the Gram-Hadamard inequality, we find $\|\det G^{N+1,T}\|_\infty^{1/2} \leq (\text{const.})^{\sum_{i=1}^s |P_{v_i}^X|} 2^{N(\frac{1}{2}\sum_{i=1}^s |P_{v_i}^X| - s + 1)}$; moreover, using Proposition 1, we find that for each normal endpoint v_i :

$$\frac{1}{|\Lambda|} \int d\mathbf{x}_{v_i} |K_{v_i}^{(N+1)}(\mathbf{x}_{v_i})| \leq (C|\lambda|)^{\max\{1, c|P_{v_i}|\}} 2^{N(2 - \frac{1}{2}|P_{v_i}^\psi| - \frac{1}{2}|P_{v_i}^X| - |P_{v_i}^A|)}. \quad (3.16)$$

Substituting these estimates into Eq.(3.9) we find that for fixed P_{v_0} the contribution to the kernel of $\psi_{P_{v_0}} A_{P_{v_0}}$ from a given tree $\tau \in \mathcal{T}_{N;n,m}^{(N)}$ can be estimated by

$$C^{n+m} |\lambda|^{\max\{1, cn\}} 2^{N(2 - \frac{1}{2}|P_{v_0}^\psi| - |P_{v_0}^A|)}, \quad (3.17)$$

where we used the small factors $|\lambda|^{\max\{1, c|P_{v_i}^X\}}$ to sum over the field labels, see [25, Appendix A6]. Eq.(3.17) implies the analyticity in λ of the kernels of $\tilde{\mathcal{V}}^{(N)}$ and of $\mathcal{B}^{(N)}$, as well as their exponential decay on scale $a = 2^{-N}$. In particular, writing

$$\tilde{\mathcal{V}}^{(N)}(\psi, \mathbf{A}) = \sum_{n \geq 1, m \geq 0}^* \sum_{\underline{\omega}, \underline{j}} \int d\underline{\mathbf{x}} d\underline{\mathbf{y}} \tilde{W}_{2n, m; \underline{\omega}, \underline{j}}^{(N)}(\underline{\mathbf{x}}; \underline{\mathbf{y}}) \left[\prod_{i=1}^{2n} \psi_{\mathbf{x}_i, \omega_i} \right] \left[\prod_{i=1}^m A_{\mathbf{y}_i, j_i} \right], \quad (3.18)$$

where the $*$ on the sum indicates the constraint that $(2n, m) \neq (2, 1)$, we have

$$\frac{1}{|\Lambda|} \int d\mathbf{x}_1 \cdots d\mathbf{y}_m |\tilde{W}_{2n, m; \underline{\omega}, \underline{j}}^{(h)}(\mathbf{x}_1, \dots, \mathbf{x}_{2n}; \mathbf{y}_1, \dots, \mathbf{y}_m)| \leq C^{m+m} 2^{N(2-2n-m)} |\lambda|^{cn} \quad (3.19)$$

A similar expansion and similar bounds are valid for $\mathcal{S}^{(N)}(\mathbf{A})$ as well.

3.2 The iterative integration

We are now left with the integration of the ψ field. Recall that the propagator of the ψ field is given by the inverse of $C_\sigma(\mathbf{k})$, see Eq.(2.61), which has a mass (i.e. an inverse decay rate) proportional to $\sigma = \sigma(a)$, which can be arbitrarily small. In fact, recall that $\sigma(a) \neq 0 \forall a > 0$, and $\lim_{a \rightarrow 0} \sigma(a) = m^* \in \mathbb{R}$. In particular, $m^* = 0$ is an allowed value of the rescaled mass and it is our purpose to derive bounds that are uniform in m^* for $m^* \rightarrow 0$ (massless limit). In this respect, ψ is essentially a massless field or, more precisely, it is non-uniformly massive. Therefore, we cannot trivially integrate ψ “in one step”, as we did for χ . A convenient procedure is the following. We define a sequence of geometrically decreasing momentum scales 2^h , with $h = N, N-1, \dots$. Correspondingly we define a sequence of analytic functions $f_h(\mathbf{k})$ supported mostly around $|\mathbf{k}| \sim 2^h$: for instance, we can choose $f_N(\mathbf{k}) = 1 - \exp\{-2^{-2(N-1)}\mathbf{k}^2\}$ and $f_h(\mathbf{k}) = \exp\{-2^{-2h}\mathbf{k}^2\} - \exp\{-2^{-2(h-1)}\mathbf{k}^2\}$, $\forall h < N$, so that

$$1 = \sum_{h \leq N} f_h(\mathbf{k}) . \quad (3.20)$$

The resolution of the identity Eq.(3.20) induces a rewriting of the propagator of $\psi =: \psi^{(\leq N)}$ as a sum of propagators concentrated on smaller and smaller momentum scales and an iterative procedure to compute $\Xi_{-, -}(\mathbf{A})$. At each step we decompose the propagator into a sum of two propagators, the first approximately supported on momenta $\sim 2^h$ (i.e. with a Fourier transform proportional to $f_h(\mathbf{k})$), $h \leq 0$, the second approximately supported on momenta smaller than 2^h , $h \leq N$. Correspondingly we rewrite the Grassmann field as a sum of two independent fields: $\psi^{(\leq h)} = \psi^{(h)} + \psi^{(\leq h-1)}$ and we integrate out the field $\psi^{(h)}$ in the same way as we did for χ . The result is that, for any $h \leq N$, we can rewrite Eq.(3.1) as

$$\Xi_{-, -}(\mathbf{A}) = e^{|\Lambda|F_h + S^{(h)}(\mathbf{A})} \int P_{\chi_h, Z_h, \sigma_h}(d\psi^{(\leq h)}) e^{\mathcal{V}^{(h)}(\psi^{(\leq h)}, \mathbf{A}) + \mathcal{B}^{(h)}(\psi^{(\leq h)}, \mathbf{A})} , \quad (3.21)$$

where $F_h, Z_h, \sigma_h, \mathcal{V}^{(h)}, \mathcal{B}^{(h)}$ will be defined recursively, $\chi_h(\mathbf{k}) = \sum_{k \leq h} f_k(\mathbf{k})$ and $P_{\chi_h, Z_h, \sigma_h}(d\psi^{(\leq h)})$ is the gaussian integration with propagator (recall the definition $D_a^\pm = a^{-1}(i \sin ak_1 \pm \sin ak_2)$)

$$g^{(\leq h)}(\mathbf{x}) = \frac{2\pi}{Z_h} \frac{1}{L^2} \sum_{\mathbf{k} \in \mathcal{D}_M} \frac{e^{-i\mathbf{k}\mathbf{x}} \chi_h(\mathbf{k})}{|D_a(\mathbf{k})|^2 + \sigma_h^2} \begin{pmatrix} D_a^+(\mathbf{k}) & i\sigma_h \\ -i\sigma_h & D_a^-(\mathbf{k}) \end{pmatrix} . \quad (3.22)$$

If $h = N$, then: $Z_N = 1$, $\sigma_N = \sigma(a) = \sigma$ and

$$\mathcal{V}^{(N)}(\psi, \mathbf{A}) = \tilde{\mathcal{V}}^{(N)}(\psi, \mathbf{A}) - \frac{1}{4\pi L^2} \sum_{\mathbf{k} \in \mathcal{D}_M} \psi_{-\mathbf{k}}^T \left[C_\sigma(\mathbf{k}) + \begin{pmatrix} D_a^-(\mathbf{k}) & -i\sigma \\ i\sigma & D_a^+(\mathbf{k}) \end{pmatrix} \right] \psi_{\mathbf{k}} \quad (3.23)$$

In the following steps, the *effective potential* $\mathcal{V}^{(h)}$ and the effective source term $\mathcal{B}^{(h)}$ will be shown to have the following structure: $\mathcal{B}^{(h)}(\psi, \mathbf{A})$ is quadratic in ψ and linear in \mathbf{A} , while $\mathcal{V}^{(h)}$ admits an expansion analogous to Eq.(3.18)

$$\mathcal{V}^{(h)}(\psi, \mathbf{A}) = \sum_{\substack{n, m \geq 0 \\ n+m \geq 1}}^* \sum_{\underline{\omega}, \underline{j}} \int d\underline{\mathbf{x}} d\underline{\mathbf{y}} W_{2n, m; \underline{\omega}, \underline{j}}^{(h)}(\underline{\mathbf{x}}; \underline{\mathbf{y}}) \left[\prod_{i=1}^{2n} \psi_{\mathbf{x}_i, \omega_i} \right] \left[\prod_{i=1}^m A_{\mathbf{y}_i, j_i} \right], \quad (3.24)$$

where, as we will see below,

$$\frac{1}{|\Lambda|} \int d\mathbf{x}_1 \cdots d\mathbf{y}_m |W_{2n, m; \underline{\omega}, \underline{j}}^{(h)}(\mathbf{x}_1, \dots, \mathbf{x}_{2n}; \mathbf{y}_1, \dots, \mathbf{y}_m)| \leq C^{n+m} 2^{h(2-2n-m)} |\lambda|^{cn} \quad (3.25)$$

The iteration continues until the scale $h = h_\sigma := \lfloor \log_2 \sigma(a) \rfloor$ is reached. At that point, the left-over propagator, $g^{(\leq h_\sigma)}$ is massive on the “right scale” (i.e. on the very same scale 2^{h_σ}), so that the associated degrees of freedom can be integrated in one step. The result is the desired generating function, from which we can finally compute the multi-point energy correlation functions.

3.3 Localization and renormalization

In order to inductively prove Eq.(3.21) we write

$$\mathcal{V}^{(h)}(\psi, \mathbf{A}) = \mathcal{L}\mathcal{V}^{(h)}(\psi) + \mathcal{R}\mathcal{V}^{(h)}(\psi, \mathbf{A}), \quad (3.26)$$

where, if we think of the kernel $\hat{W}_{2,0;(\omega_1, \omega_2)}^{(h)}$ as a 2×2 matrix with matrix indices ω_1, ω_2 ,

$$\begin{aligned} \mathcal{L}\mathcal{V}^{(h)}(\psi) &= \quad (3.27) \\ &= \frac{1}{L^2} \sum_{\mathbf{k} \in \mathcal{D}_M} \hat{\psi}_{-\mathbf{k}}^T \left[(\mathcal{P}_0 + \mathcal{P}_1) \hat{W}_{2,0}^{(h)}(\mathbf{0}) + \mathbf{d}_a(\mathbf{k}) \cdot \partial_{\mathbf{k}} \mathcal{P}_0 \hat{W}_{2,0}^{(h)}(\mathbf{0}) \right] \hat{\psi}_{\mathbf{k}} + \\ &+ \sum_{\omega_1, \omega_2, \omega_3, \omega_4} \int d\mathbf{x}_1 \cdots d\mathbf{x}_4 W_{4,0; \underline{\omega}}(\mathbf{x}_1, \mathbf{x}_2, \mathbf{x}_3, \mathbf{x}_4) \psi_{\mathbf{x}_1, \omega_1}^{(\leq h)} \psi_{\mathbf{x}_1, \omega_2}^{(\leq h)} \psi_{\mathbf{x}_1, \omega_3}^{(\leq h)} \psi_{\mathbf{x}_1, \omega_4}^{(\leq h)}, \end{aligned}$$

Here \mathcal{P}_0 (resp. \mathcal{P}_1) is an operator that extracts the order 0 (resp. order 1) in $\{\sigma_k\}_{k>h}$ from the kernel which it acts on, and $\mathbf{d}_a(\mathbf{k}) := a^{-1}(\sin ak_1, \sin ak_2)$.

Remarks.

1. \mathcal{L} will be called the *localization operator*, which should be thought of as the linear operator extracting from the effective potential $\mathcal{V}^{(h)}$ its local (singular) part, while \mathcal{R} will be called the *renormalization operator*, which is the linear operator extracting from $\mathcal{V}^{(h)}$ its regular part. Note that the action of \mathcal{R} on the kernels quadratic in ψ is equivalent (via the use of the remainder's formula in the Taylor's expansion) to the action of a second order differential operator of the type $\mathbf{k}^2 \partial_{\mathbf{k}}^2$ or $\sum_{k>h} \sigma_k^2 \partial_{\sigma_k}^2$ (or a suitable combination of the two). Dimensionally, the differential operator $\mathbf{k}^2 \partial_{\mathbf{k}}^2$ (or, equivalently, its \mathbf{x} -space counterpart, which is of the form $\mathbf{x}^2 \partial_{\mathbf{x}}^2$) behaves as $2^{2(h_1-h_2)}$, where h_1 is the scale of \mathbf{k} and h_2 the scale of the propagator that $\partial_{\mathbf{k}}$ acts on; moreover, the iterative integration is set up in such a way that by construction $h_1 < h_2$, so that $2^{2(h_1-h_2)}$ is a dimensional gain, sufficient to regularize the quadratic kernels of the effective potential. Similarly, the action of the operator $\sum_{k>h} \sigma_k^2 \partial_{\sigma_k}^2$ on the kernels quadratic in ψ is dimensionally equivalent to a multiplication by $\sigma_h^2 2^{-2h} \simeq \left(\frac{\sigma_h}{\sigma_{h\sigma}}\right)^2 2^{2(h\sigma-h)}$; as we will see, $\sigma_h \simeq \sigma = \sigma(a)$ at all scales, so that the action of $\sum_{k>h} \sigma_k^2 \partial_{\sigma_k}^2$ is dimensionally equivalent to a multiplication by the gain factor $2^{2(h\sigma-h)}$ which is enough to regularize the quadratic kernels of the effective potential. A similar discussion is valid for the action of \mathcal{R} on the quartic kernels.
2. A key fact which makes the theory at hand treatable (and asymptotically free) is that the quartic term in the second line is zero “by the Pauli principle”, i.e., simply by the Grassmann rule $\psi_{\mathbf{x},\omega}^2 = 0$. In fact, note that at least two of the four ω indices must be equal among each other. Therefore the integrand in the second line is identically zero. This property can be diagrammatically interpreted by saying that the fermionic nature of the theory automatically renormalizes the four-field interaction, which is dimensionally marginal (see below) but effectively irrelevant thanks to the cancellation that we just mentioned.

Similarly, we decompose the source term as

$$\mathcal{B}^{(h)}(\psi, \mathbf{A}) = \mathcal{L}\mathcal{B}^{(h)}(\psi, \mathbf{A}) + \mathcal{R}\mathcal{B}^{(h)}(\psi, \mathbf{A}) , \quad (3.28)$$

with

$$\mathcal{L}\mathcal{B}^{(h)}(\psi, \mathbf{A}) = \frac{1}{L^4} \sum_{\mathbf{k}, \mathbf{p} \in \mathcal{D}_M} (\hat{A}_{\mathbf{p},1} + \hat{A}_{\mathbf{p},2}) \psi_{-\mathbf{k}-\mathbf{p}}^T \mathcal{P}_0 \hat{W}_{2,1}^{(h)}(\mathbf{0}) \hat{\psi}_{\mathbf{k}} , \quad (3.29)$$

where $\hat{A}_{\mathbf{p},j} = \int d\mathbf{x} e^{i\mathbf{p}\mathbf{x}} A_{\mathbf{x},j}$. As we will see below, $\mathcal{L}\mathcal{B}^{(h)}$ is a marginal operator in the Renormalization Group sense.

The symmetries of the theory, which are described in Sec.2.4 and are preserved by the iterative integration procedure, imply that the kernel in the second line of Eq.(3.27) has a structure analogous to Eq.(2.68); we also choose to separate the mass term (i.e. the constant in the off-diagonal elements of the matrix) in two parts, one proportional to the bare mass and one independent of it, namely:

$$\begin{aligned}\mathcal{L}\mathcal{V}^{(h)}(\psi) &= \frac{1}{L^2} \sum_{\mathbf{k}} \hat{\psi}_{-\mathbf{k}}^T \left[\frac{1}{4\pi} \begin{pmatrix} \zeta_h D_a^-(\mathbf{k}) & -is_h \\ is_h & \zeta_h D_a^+(\mathbf{k}) \end{pmatrix} + 2^h \nu_h \sigma_2 \right] \hat{\psi}_{\mathbf{k}} \\ &=: \mathcal{L}_0 \mathcal{V}^{(h)}(\psi) + 2^h \nu_h F_\nu(\psi),\end{aligned}\quad (3.30)$$

where $F_\nu(\psi) := \int d\mathbf{x} \psi_{\mathbf{x}} \sigma_2 \psi_{\mathbf{x}}$ and ζ_h, s_h, ν_h are suitable real constants, such that s_h is linear in $\{\sigma_k\}_{k>h}$ and ν_h is independent of $\{\sigma_k\}_{k>h}$. Note that the counterterm on scale $h = N$ is defined so that

$$\nu_N := \nu + 2^{-N-1} \text{Tr}[\sigma_2 \mathcal{P}_0 \hat{W}_{2,0}^{(N)}(\mathbf{0})]. \quad (3.31)$$

We stress once again that the local part of $\mathcal{V}^{(h)}$ is purely quadratic in ψ : the quartic term, a priori present in $\mathcal{L}\mathcal{V}^{(h)}$ is zero thanks to the ‘‘Pauli principle’’, in the sense of the Remark 2 above. Similarly, the local part of the source term can be written as

$$\mathcal{L}\mathcal{B}^{(h)} = \frac{Z_h^{(1)}}{2\pi} \int d\mathbf{x} (A_{\mathbf{x},1} + A_{\mathbf{x},2}) \psi_{\mathbf{x}} \sigma_2 \psi_{\mathbf{x}}. \quad (3.32)$$

for a suitable real constant $Z_h^{(1)}$, with $Z_N^{(1)} = 1$.

Once that the above definitions are given, we can describe our iterative integration procedure for $h \leq N$. We start from Eq.(3.21), which is inductively assumed to be valid at the h -th step, and we prove the validity of the representation for $h - 1$. We rewrite Eq.(3.21) as

$$\begin{aligned}e^{|\Lambda|F_h + \mathcal{S}^{(h)}(\mathbf{A})} &\int P_{\chi_h, Z_h, \sigma_h} (d\psi^{(\leq h)}) e^{\mathcal{L}_0 \mathcal{V}^{(h)}(\psi^{(\leq h)}) + 2^h \nu_h F_\nu(\psi^{(\leq h)})} \\ &\cdot e^{\mathcal{R}\mathcal{V}^{(h)}(\psi^{(\leq h)}, \mathbf{A}) + \mathcal{B}^{(h)}(\psi^{(\leq h)}, \mathbf{A})}\end{aligned}\quad (3.33)$$

Next we include $\mathcal{L}_0 \mathcal{V}^{(h)}$ in the fermionic integration, so obtaining

$$\begin{aligned}e^{|\Lambda|(F_h + e_h) + \mathcal{S}^{(h)}(\mathbf{A})} &\int P_{\chi_h, \bar{Z}_{h-1}, \bar{\sigma}_{h-1}} (d\psi^{(\leq h)}) e^{2^h \nu_h F_\nu(\psi^{(\leq h)})} \\ &\cdot e^{\mathcal{R}\mathcal{V}^{(h)}(\psi^{(\leq h)}, \mathbf{A}) + \mathcal{B}^{(h)}(\psi^{(\leq h)}, \mathbf{A})}\end{aligned}\quad (3.34)$$

where

$$\bar{Z}_{h-1}(\mathbf{k}) = Z_h + \zeta_h \chi_h(\mathbf{k}), \quad \bar{\sigma}_{h-1}(\mathbf{k}) = Z_h \sigma_h + s_h \chi_h(\mathbf{k}), \quad (3.35)$$

and e_h is a constant fixed in such a way that $\int P_{\chi_h, \bar{Z}_{h-1}, \bar{\sigma}_{h-1}}(d\psi^{(\leq h)}) = 1$. Now we can perform the integration of the $\psi^{(h)}$ field. We rewrite the Grassmann field $\psi^{(\leq h)}$ as a sum of two independent Grassmann fields $\psi^{(\leq h-1)} + \psi^{(h)}$ and correspondingly, if we let $Z_{h-1} := \bar{Z}_{h-1}(\mathbf{0})$ and $\sigma_{h-1} := \bar{\sigma}_{h-1}(\mathbf{0})$, we rewrite Eq.(3.34) as

$$e^{|\Lambda|(F_h + e_h) + \mathcal{S}^{(h)}(\mathbf{A})} \int P_{\chi_{h-1}, Z_{h-1}, \sigma_{h-1}}(d\psi^{(\leq h-1)}) \int P_{\tilde{f}_h, Z_{h-1}, \tilde{\sigma}_{h-1}}(d\psi^{(h)}) \cdot e^{2^h \nu_h F_\nu(\psi^{(\leq h-1)} + \psi^{(h)}) + \mathcal{R}\mathcal{V}^{(h)}(\psi^{(\leq h-1)} + \psi^{(h)}, \mathbf{A}) + \mathcal{B}^{(h)}(\psi^{(\leq h-1)} + \psi^{(h)}, \mathbf{A})}$$

where

$$\begin{aligned} \tilde{f}_h(\mathbf{k}) &= Z_{h-1} \left[\frac{\chi_h(\mathbf{k})}{\bar{Z}_{h-1}(\mathbf{k})} \frac{|D_a(\mathbf{k})|^2 + \sigma_{h-1}^2}{|D_a(\mathbf{k})|^2 + \bar{\sigma}_{h-1}^2(\mathbf{k})} - \frac{\chi_{h-1}(\mathbf{k})}{Z_{h-1}} \right], \\ \tilde{f}_h(\mathbf{k}) \tilde{\sigma}_{h-1}(\mathbf{k}) &= [\tilde{f}_h(\mathbf{k}) + \chi_{h-1}(\mathbf{k})] \bar{\sigma}_{h-1}(\mathbf{k}) - \chi_{h-1}(\mathbf{k}) \sigma_{h-1}. \end{aligned}$$

The single scale propagator is

$$g^{(h)}(\mathbf{x} - \mathbf{y}) = \frac{2\pi}{Z_{h-1}} \frac{1}{L^2} \sum_{\mathbf{k} \in \mathcal{D}_M} \frac{e^{-i\mathbf{k}\mathbf{x}} \tilde{f}_h(\mathbf{k})}{|D_a(\mathbf{k})|^2 + \bar{\sigma}_{h-1}^2(\mathbf{k})} \begin{pmatrix} D_a^+(\mathbf{k}) & i\tilde{\sigma}_{h-1}(\mathbf{k}) \\ -i\tilde{\sigma}_{h-1}(\mathbf{k}) & D_a^-(\mathbf{k}) \end{pmatrix}. \quad (3.36)$$

A key remark is that, if $|Z_h - 1| \leq (\text{const.})|\lambda|$ and $|\sigma_h - \sigma| \leq (\text{const.})|\sigma\lambda|$ (as we shall inductively prove below) and for all scales larger than h_σ , the propagator $g^{(h)}$ satisfies a bound analogous to Eq.(3.11):

$$\|g^{(h)}(\mathbf{x} - \mathbf{y})\| \leq C 2^h e^{-c 2^h |\mathbf{x} - \mathbf{y}|}. \quad (3.37)$$

Therefore, we can integrate the field on scale h in the same way as we did for χ , after which we are left with an integral involving the fields $\psi^{(\leq h-1)}$ and the new effective interaction, defined as

$$\begin{aligned} e^{|\Lambda|[\bar{e}_h + \bar{\mathcal{S}}_{h-1}(\mathbf{A}) + \mathcal{V}^{(h-1)}(\psi^{(\leq h-1)}, \mathbf{A}) + \mathcal{B}^{(h-1)}(\psi^{(\leq h-1)}, \mathbf{A})} &= \\ = \int P_{\tilde{f}_h, Z_{h-1}, \tilde{\sigma}_{h-1}}(d\psi^{(h)}) e^{\widehat{\mathcal{V}}^{(h)}(\psi^{(\leq h-1)} + \psi^{(h)}, \mathbf{A})}, \end{aligned} \quad (3.38)$$

where

$$\widehat{\mathcal{V}}^{(h)}(\psi) = 2^h \nu_h F_\nu(\psi) + \mathcal{L}\mathcal{B}^{(h)}(\psi, \mathbf{A}) + \mathcal{R}\mathcal{V}^{(h)}(\psi, \mathbf{A}) + \mathcal{R}\mathcal{B}^{(h)}(\psi, \mathbf{A}),$$

and $\mathcal{V}^{(h-1)}(0, \mathbf{A}) = 0$, so that $F_{h-1} = F_h + e_h + \bar{e}_h$ and $\mathcal{S}^{(h-1)}(\mathbf{A}) = \mathcal{S}^{(h)}(\mathbf{A}) + \bar{\mathcal{S}}_{h-1}(\mathbf{A})$, while $\mathcal{B}^{(h-1)}(\psi, \mathbf{A})$ collects all the terms quadratic in ψ and linear

in \mathbf{A} . The potential $\mathcal{V}^{(h-1)}$ is of the form Eq.(3.24) as one sees by using the identity

$$\begin{aligned} |\Lambda| \bar{e}_h + \bar{\mathcal{S}}_{h-1}(\mathbf{A}) + \mathcal{V}^{(h-1)}(\psi^{(\leq h-1)}, \mathbf{A}) + \mathcal{B}^{(h-1)}(\psi^{(\leq h-1)}, \mathbf{A}) &= \quad (3.39) \\ &= \sum_{n \geq 1} \frac{1}{n!} \mathcal{E}_h^T \left(\underbrace{\widehat{\mathcal{V}}^{(h)}(\psi^{(\leq h-1)} + \psi^{(h)}, \mathbf{A}); \dots; \widehat{\mathcal{V}}^{(h)}(\psi^{(\leq h-1)} + \psi^{(h)}, \mathbf{A})}_{n \text{ times}} \right), \end{aligned}$$

where \mathcal{E}_h^T is the truncated expectation w.r.t. the propagator $g^{(h)}$.

The iteration continues up to scale h_σ . At that point, we integrate in one step all the remaining degrees of freedom, by taking advantage of the fact that

$$\|g^{(\leq h_\sigma)}(\mathbf{x} - \mathbf{y})\| \leq C 2^{h_\sigma} e^{-c 2^{h_\sigma} |\mathbf{x} - \mathbf{y}|}, \quad (3.40)$$

where by definition 2^{h_σ} is of the same order as $\sigma = \sigma(a) \neq 0$. After the integration of $\psi^{(\leq h_\sigma)}$ we are left with the desired generating function, $\log \Xi_{-, -}(\mathbf{A})$.

Note that the above procedure allows us to write the *effective constants* $(Z_h, \sigma_h, \nu_h, Z_h^{(1)})$ with $h \leq N$, in terms of $(Z_k, \sigma_k, \nu_k, Z_k^{(1)})$ with $h < k \leq N$:

$$Z_{h-1} = Z_h + \beta_h^Z, \quad \frac{\sigma_{h-1}}{\sigma_h} = 1 + \beta_h^\sigma, \quad (3.41)$$

$$\nu_{h-1} = 2\nu_h + \beta_h^\nu, \quad \frac{Z_{h-1}^{(1)}}{Z_h^{(1)}} = 1 + \beta_h^{Z,1}, \quad (3.42)$$

where $\beta_h^\# = \beta_h^\#((Z_h, \sigma_h, \nu_h, Z_h^{(1)}), \dots, (Z_N, \sigma_N, \nu_N, Z_N^{(1)}))$ is the so-called *Beta function*.

The effective constants, sometimes called the *running coupling constants* measure the strength of the local part of the effective potential. The key point, to be proved below, is that, if we assume that the running coupling constants stay close to their bare values at scale N , then the expansion for the effective potential induced by the iterative procedure above, is well defined and *analytic* in the sequence of running coupling constants. Moreover, under the same assumptions, the beta function itself is well defined and analytic in the running coupling constants: this allows us to study the evolution of these effective constants under the dynamical system defined by $\beta_h^\#$. We will see that, *uniformly* in h ,

$$Z_h = 1 + O(\lambda), \quad Z_h^{(1)} = 1 + O(\lambda), \quad \nu_h = O(\lambda), \quad \sigma_h = \sigma(1 + O(\lambda)), \quad (3.43)$$

where $\sigma = \sigma(a)$. The boundedness of the flow of the running coupling constants, Eq.(3.43), is one of the key ingredients that allow us to prove the analyticity of the theory in the bare coupling constants, see below.

3.4 Tree expansion for the effective potential

In order to prove the analyticity properties of the effective potential announced in the previous section, we first need to prove that the kernels of the effective potential, as obtained from the iterative procedure described above, are expressed by absolutely convergent series in the sequence of the running coupling constants, provided that these are assumed to be close to their bare values at scale $h = N$. Then we will show that this assumption is justified, by proving that their flow under the beta function remains bounded. In any case, as a first step towards the full control of the theory, we need a more explicit representation of the kernels of the effective potential and a systematic and efficient way to bound them. The idea is to systematically represent the action of \mathcal{E}_h^T in Eq.(3.39) in a way analogous to the one described in Section 3.1 for the integration of the χ field. By iterating the graphical equation Fig.6 we obtain a tree expansion for the effective potential, which has been first introduced by G. Gallavotti and F. Nicolò in [24] and since then it has been described in detail in several papers that make use of constructive renormalization group methods, see e.g. [21] and the more recent reviews [25, 26, 42]. The main features of this expansion (to be referred to as the expansion in Gallavotti-Nicolò trees, or in GN trees for short) are described below.

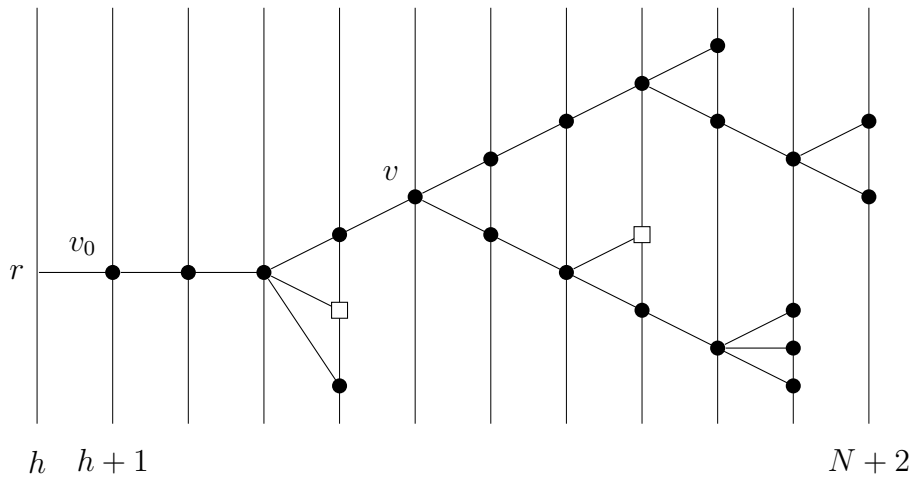

Figure 7: A tree $\tau \in \mathcal{T}_{N;n,m}^{(h)}$ with $n = 7$ and $m = 2$: the root is on scale h and the endpoints are on scales $\leq N + 2$.

1. Let us consider the family of all trees which can be constructed by joining a point r , the *root*, with an ordered set of $n + m \geq 1$ points,

the *endpoints* of the *unlabeled tree*, so that r is not a branching point. The endpoints can be of two types, either normal or special, the first drawn as black dots, the second as open squares, see Fig.7; n and m indicate the number of normal and special endpoints, respectively. The branching points will be called the *non trivial vertices*. The unlabeled trees are partially ordered from the root to the endpoints in the natural way; we shall use the symbol $<$ to denote the partial order. Two unlabeled trees are identified if they can be superposed by a suitable continuous deformation, so that the endpoints with the same index coincide. We shall also consider the *labelled trees* (to be called simply trees in the following); they are defined by associating some labels with the unlabelled trees, as explained in the following items.

2. We associate a label $0 \leq h \leq N$ with the root and we denote by $\mathcal{T}_{N;n,m}^{(h)}$ the corresponding set of labeled trees with n normal and m special endpoints. Moreover, we introduce a family of vertical lines, labeled by an integer taking values in $[h, N + 2]$, and we represent any tree $\tau \in \mathcal{T}_{N;n,m}^{(h)}$ so that, if v is an endpoint, it is contained in a vertical line with index $h + 1 < h_v \leq N + 2$, while if it is a non trivial vertex, it is contained in a vertical line with index $h < h_v \leq N + 1$, to be called the *scale* of v ; the root r is on the line with index h . In general, the tree will intersect the vertical lines in set of points different from the root, the endpoints and the branching points; these points will be called *trivial vertices*. The set of the *vertices* will be the union of the endpoints, of the trivial vertices and of the non trivial vertices; note that the root is not a vertex. Every vertex v of a tree will be associated to its scale label h_v , defined, as above, as the label of the vertical line whom v belongs to. Note that, if v_1 and v_2 are two vertices and $v_1 < v_2$, then $h_{v_1} < h_{v_2}$.
3. There is only one vertex immediately following the root, called v_0 and with scale label equal to $h + 1$.
4. Given a vertex v of $\tau \in \mathcal{T}_{N;n,m}^{(h)}$ that is not an endpoint, we can consider the subtrees of τ with root v , which correspond to the connected components of the restriction of τ to the vertices $w \geq v$. If a subtree with root v contains only v and one endpoint on scale $h_v + 1$, it will be called a *trivial subtree*.
5. With each normal (resp. special) endpoint v on scale $N + 2$ we associate a factor $\bar{\mathcal{V}}(\psi^{(\leq N)}, \chi, \mathbf{A})$ (resp. $\bar{\mathcal{B}}(\psi^{(\leq N)}, \chi, \mathbf{A})$); here $\chi =: \psi^{(N+1)}$ should be thought of as the field on scale $N + 1$. With the endpoints on

scale $h_v \leq N + 1$ we associate a factor $2^{h_v-1} \nu_{h_v-1} F_\nu(\psi^{(\leq h_v-1)})$ if the endpoint is normal or a factor $\mathcal{LB}^{(h_v-1)}$ if the endpoint is special. The vertex v' immediately preceding an endpoint v on scale $h_v \leq N + 1$ is necessarily non trivial. Note that none of the endpoint on scale $\leq N + 1$ is associated with a quartic operator in the ψ fields: this is due to the cancellation mentioned in Remark 2 at the beginning of Sec.3.3.

In terms of these trees, the effective potential $\mathcal{V}^{(h)}$ can be written as

$$\begin{aligned} |\Lambda| \bar{e}_{h+1} + \bar{\mathcal{S}}_h(\mathbf{A}) + \mathcal{V}^{(h)}(\psi^{(\leq h)}, \mathbf{A}) + \mathcal{B}^{(h)}(\psi^{(\leq h)}, \mathbf{A}) = \\ = \sum_{\substack{n,m \geq 0 \\ n+m \geq 1}} \sum_{\tau \in \mathcal{T}_{N;n,m}^{(h)}} \mathcal{V}^{(h)}(\tau, \psi^{(\leq h)}, \mathbf{A}), \end{aligned} \quad (3.44)$$

where, if v_0 is the first vertex of τ , if τ_1, \dots, τ_s ($s = s_{v_0}$) are the subtrees of τ with root v_0 , and if \mathcal{E}_{h+1}^T is the truncated expectation associated to the propagator $g^{(h)}$,

$$\mathcal{V}^{(h)}(\tau, \psi^{(\leq h)}, \mathbf{A}) = \frac{1}{s!} \mathcal{E}_{h+1}^T(\bar{V}^{(h+1)}(\tau_1, \psi^{(\leq h+1)}, \mathbf{A}); \dots; \bar{V}^{(h+1)}(\tau_s, \psi^{(\leq h+1)}, \mathbf{A})), \quad (3.45)$$

and $\bar{V}^{(h+1)}(\tau_i, \psi^{(\leq h+1)}, \mathbf{A})$:

- is equal to $\mathcal{R}\mathcal{V}^{(h+1)}(\tau_i, \psi^{(\leq h+1)}, \mathbf{A})$ (where \mathcal{R} is the linear operator induced by the definitions Eqs.(3.26),(3.27),(3.28),(3.29)) if τ_i is non trivial;
- is equal to $2^{h+1} \nu_{h+1} F_\nu(\psi^{(\leq h+1)})$ if τ_i is trivial, $h < N$ and the endpoint of τ_i is normal;
- is equal to $\mathcal{LB}^{(h+1)}(\psi^{(\leq h+1)}, \mathbf{A})$ if τ_i is trivial, $h < N$ and the endpoint of τ_i is special;
- is equal to $\bar{V}(\psi^{(\leq N+1)}, \mathbf{A})$ (resp. $\bar{\mathcal{B}}(\psi^{(\leq N+1)}, \mathbf{A})$) if τ_i is trivial, $h = N$ and the endpoint of τ_i is normal (resp. special).

Note that, by the definition of $\bar{V}^{(h)}$, it is apparent that all the nodes that are not endpoints are associated with the action of the renormalization operator \mathcal{R} . The local (singular) parts only appear in the contributions associated with the endpoints: in this sense, the singular parts “do not accumulate”. Using its inductive definition Eqs.(3.44)-(3.45) and the Pfaffian representation for the truncated expectations, the right hand side of Eq.(3.44) can be put in a form similar to the one derived in Section 3.1 for the integration of the χ field. To do that, we further expand $\mathcal{V}^{(h)}(\tau, \psi^{(\leq h)}, \mathbf{A})$ by distinguishing

the different contributions arising from the choices of the monomials in the factors $\bar{\mathcal{V}}$ and $\bar{\mathcal{B}}$ associated with the endpoints on scale $N + 2$, as well as the scale at which each field in these monomials is contracted. To this purpose, we introduce a few more definitions, which generalize the definition of P_v in Sec.3.1.

We introduce a *field label* f to distinguish the field variables appearing in the monomials associated with the endpoints; the set of field labels associated with the endpoint v will be called I_v ; if v is not an endpoint, we shall call I_v the set of field labels associated with the endpoints following the vertex v . Note that every field can be either of type A or ψ : correspondingly, we denote by I_v^A and I_v^ψ the set of field labels of type A and ψ , respectively, associated with v . Furthermore, we denote by $\mathbf{x}(f)$ the space-time point of the field variable with label f ; if $f \in I_v^A$, we denote by $j(f)$ the j index of the external field with label f ; if $f \in I_v^\psi$, we denote by $\omega(f)$ the ω index of the Grassmann field with label f .

We associate with any vertex v of the tree a subset P_v of I_v , the *external fields* of v ; we further denote by P_v^A and P_v^ψ the subsets of P_v of fields of type A and ψ , respectively (of course, $P_v^A \cap P_v^\psi = \emptyset$ and $P_v^A \cup P_v^\psi = P_v$). These subsets must satisfy various constraints. First of all, if v is not an endpoint and v_1, \dots, v_{s_v} are the $s_v \geq 1$ vertices immediately following it, then $P_v \subseteq \cup_i P_{v_i}$; if v is an endpoint, $P_v = I_v$. If v is not an endpoint, we shall denote by Q_{v_i} the intersection of P_v and P_{v_i} ; this definition implies that $P_v = \cup_i Q_{v_i}$. The union of the subsets $P_{v_i} \setminus Q_{v_i}$ is, by definition, the set of the *internal fields* of v , and is non empty if $s_v > 1$. Similar definitions are valid for $Q_{v_i}^\psi, Q_{v_i}^A$, etc. Note that $P_v^A = Q_v^A$ for all v , simply because A is, by definition, an external field. Given $\tau \in \mathcal{T}_{N;n,m}^{(h)}$, there are many possible choices of the subsets $P_v, v \in \tau$, compatible with all the constraints. We shall denote by \mathcal{P}_τ the family of all these choices and by \mathbf{P} the elements of \mathcal{P}_τ .

Let us note that the resulting expansion for the effective potential, as compared to the expansion for $\tilde{\mathcal{V}}^{(N)}$ described in Sec. 3.1, has an important difference related to the iterative action of the \mathcal{R} operator on the nodes of τ that are not endpoints; as observed in the first Remark at the beginning of Sec.3.3, this is equivalent to the action of a suitable differential operator, whose precise form has been discussed in several papers on the subject, see e.g. [9, 10, 11]; fortunately, in our context we do not need to describe the form of the interpolation operator exactly, but only some of its general properties, discussed in the following.

3.4.1 The non-renormalized expansion

Let us start with describing the basic dimensional bounds of the effective potential, *temporarily neglecting the action of the renormalization operator*. More precisely, let us temporarily pretend that the action of \mathcal{R} on the nodes of τ that are not endpoints, induced by definition Eq.(3.45) and by the first item immediately following it, is replaced by the identity. Then the result of the iteration would lead to the following relation:

$$\mathcal{V}_*^{(h)}(\tau, \psi^{(\leq h)}, \mathbf{A}) = \sum_{\mathbf{P} \in \mathcal{P}_\tau} \sum_{T \in \mathbf{T}} \int d\mathbf{x}_{v_0} W_{\tau, \mathbf{P}, \mathbf{T}}^*(\mathbf{x}_{v_0}) \psi_{P_{v_0}^\psi}^{(\leq h)} A_{P_{v_0}^A}, \quad (3.46)$$

where \mathbf{x}_{v_0} is the set of integration variables associated with τ and $T = \bigcup_{v \text{ not e.p.}} T_v$ is the union of the spanning trees associated with all the nodes that are not endpoints in τ . Moreover, $W_{\tau, \mathbf{P}, \mathbf{T}}^*$ is given by

$$\begin{aligned} W_{\tau, \mathbf{P}, \mathbf{T}}^*(\mathbf{x}_{v_0}) &= \\ &= \left[\prod_{v \text{ e.p.}} K_v^{(h_v)}(\mathbf{x}_v) \right] \left\{ \prod_{v \text{ not e.p.}} \frac{1}{s_v!} \int dP_{T_v}(\mathbf{t}_v) \text{Pf } G^{h_v, T_v}(\mathbf{t}_v) \left[\prod_{\ell \in T_v} g_\ell^{(h_v)} \right] \right\}, \end{aligned} \quad (3.47)$$

which can be thought of as the multiscale version of the expansion derived in Section 3.1. Here s_v indicates the number of nodes immediately following v on τ .

Eq.(3.47) can be bounded in a way analogous to Eq.(3.9); roughly speaking the rationale is that each $g_\ell^{(h_v)}$ is replaced by its L_1 norm, which dimensionally is proportional to 2^{-h_v} , and each $\text{Pf } G^{h_v, T_v}(\mathbf{t}_v)$ by the square root of its L_∞ norm, which dimensionally is proportional to $2^{h_v(\frac{1}{2} \sum_{i=1}^{s_v} |P_{v_i}^\psi| - \frac{1}{2} |P_v^\psi| - s_v + 1)}$. The result is

$$\begin{aligned} \frac{1}{|\Lambda|} \int d\mathbf{x}_{v_0} |W_{\tau, \mathbf{P}, \mathbf{T}}^*(\mathbf{x}_{v_0})| &\leq C^{n+m} \sum_{\mathbf{P}} \left[\prod_{v \text{ normal e.p.}} (C|\lambda|)^{\max\{1, c|P_v^\psi|\}} \right] \cdot \\ &\cdot \left[\prod_{v \text{ not e.p.}} \frac{1}{s_v!} 2^{-h_v(s_v-1)} 2^{h_v(\frac{1}{2} \sum_{i=1}^{s_v} |P_{v_i}^\psi| - \frac{1}{2} |P_v^\psi| - s_v + 1)} \right] \left[\prod_{v \text{ e.p.}} 2^{h_{v'}(2 - \frac{1}{2} |P_v^\psi| - |P_v^A|)} \right]. \end{aligned} \quad (3.48)$$

where in the last factor v' indicates the node immediately preceding v on τ . Note that the bound is valid provided the running coupling constants are close to their bare values. The big product in the second line can be conveniently reorganized by using the identities

$$\begin{aligned} \sum_{v \text{ not e.p.}} h_v(s_v - 1) &= h(n + m - 1) + \sum_{v \text{ not e.p.}} (h_v - h_{v'})(n(v) + m(v) - 1), \\ \sum_{v \text{ not e.p.}} h_v \left[\left(\sum_{i=1}^{s_v} |P_{v_i}^\psi| \right) - |P_v^\psi| \right] &= h(|I_{v_0}^\psi| - |P_{v_0}^\psi|) + \sum_{v \text{ not e.p.}} (h_v - h_{v'}) (|I_v| - |P_v|), \end{aligned}$$

where $n(v)$ (resp. $m(v)$) is the number of normal (resp. special) endpoints following v on τ . In the second line, $|I_{v_0}^\psi| = \sum_{v \text{ e.p.}} |P_v^\psi|$, so that, plugging these identities into Eq.(3.48) and using also the fact that $\sum_{v \text{ e.p.}} |P_v^A| = |P_{v_0}^A|$, gives:

$$\begin{aligned} \frac{1}{|\Lambda|} \int d\mathbf{x}_{v_0} |W_{\tau, \mathbf{P}, T}^*(\mathbf{x}_{v_0})| &\leq C^{n+m} \left[\prod_{v \text{ normal e.p.}} (C|\lambda|)^{\max\{1, c|P_v^\psi|\}} \right]. \\ \cdot 2^{h(2-\frac{1}{2}|P_{v_0}^\psi| - |P_{v_0}^A|)} &\left[\prod_{v \text{ not e.p.}} 2^{(h_v - h_{v'}) (2 - \frac{1}{2}|P_v^\psi| - |P_v^A|)} \right]. \end{aligned} \quad (3.49)$$

We call $d_v = -2 + \frac{|P_v^\psi|}{2} - |P_v^A|$ the *scaling dimension* of v , depending on the number of the external fields of v . If $d_v < 0$ for any v one can sum over τ, \mathbf{P}, T obtaining convergence for λ small enough; however $d_v \leq 0$ when $(|P_v^\psi|, |P_v^A|)$ is equal either to $(2, 0)$, in which case the scaling dimension is 1 (relevant operator), or to $(4, 0)$ or to $(2, 1)$, in which cases the scaling dimension is 0 (marginal operator). The apparent divergences associated with the presence of nodes with these special fields configurations is cured by the action of the regularization operator \mathcal{R} , as discussed in the following.

3.4.2 The renormalized expansion

Of course, the expansion for $\mathcal{V}^{(h)}$ described above does not lead to Eq.(3.46), but rather to a different expansion, which is similar in many respects to Eq.(3.46), modulo the presence of a certain number of interpolation operators arising from the action of \mathcal{R} on the nodes of τ that are not endpoints. The precise definition of these interpolation operators is rather technical, see e.g. Section 3 of [11]. The outcome can be expressed as

$$\begin{aligned} \mathcal{R}\mathcal{V}^{(h)}(\tau, \psi^{(\leq h)}, \mathbf{A}) &= \\ &= \sum_{\mathbf{P} \in \mathcal{P}_\tau} \sum_{T \in \mathbf{T}} \sum_{\beta \in B_T} \int d\mathbf{x}_{v_0} W_{\tau, \mathbf{P}, T, \beta}(\mathbf{x}_{v_0}) \left[\prod_{f \in P_{v_0}^\psi} \hat{\partial}_{j_\beta(f)}^{q_\beta(f)} \psi_{\mathbf{x}_\beta(f), \omega(f)}^{(\leq h)} \right] A_{P_{v_0}^A}, \end{aligned} \quad (3.50)$$

where: B_T is a set of indices which allows to distinguish the different terms produced by the non trivial \mathcal{R} operations; $\mathbf{x}_\beta(f)$ is a coordinate obtained by interpolating two points in \mathbf{x}_{v_0} , in a suitable way depending on β ; $q_\beta(f)$ is a nonnegative integer ≤ 2 ; $j_\beta(f) = 1, 2$ and $\hat{\partial}_j^q$ is a suitable differential operator, dimensionally equivalent to ∂_j^q (see [11] for a precise definition); $W_{\tau, \mathbf{P}, T, \beta}$ is given by (defining $\mathcal{S}_1 = 1 - \mathcal{P}_0$ and $\mathcal{S}_2 = 1 - \mathcal{P}_0 - \mathcal{P}_1$, as in [27];

recall that \mathcal{P}_0 and \mathcal{P}_1 were defined at the beginning of Sec.3.3):

$$\begin{aligned}
W_{\tau, \mathbf{P}, \mathbf{T}, \beta}(\mathbf{x}_{v_0}) &= \left[\prod_{v \text{ e.p.}} d_{j_\beta(v)}^{b_\beta(v)}(\mathbf{x}_{v, \beta}) \mathcal{P}_{I_\beta(v)}^{C_\beta(v)} \mathcal{S}_{i_\beta(v)}^{c_\beta(v)} K_v^{(h_v)}(\mathbf{x}_v) \right] \cdot \\
&\cdot \left\{ \prod_{v \text{ not e.p.}} \frac{1}{s_v!} \int dP_{T_v}(\mathbf{t}_v) \mathcal{P}_{I_\beta(v)}^{C_\beta(v)} \mathcal{S}_{i_\beta(v)}^{c_\beta(v)} \text{Pf } G^{h_v, T_v}(\mathbf{t}_v) \cdot \right. \\
&\cdot \left. \left[\prod_{\ell \in T_v} \hat{\partial}_{j_\beta(f_\ell^1)}^{q_\beta(f_\ell^1)} \hat{\partial}_{j_\beta(f_\ell^2)}^{q_\beta(f_\ell^2)} [d_{j_\beta(\ell)}^{b_\beta(\ell)}(\mathbf{x}_\ell - \mathbf{x}'_\ell) \mathcal{P}_{I_\beta(\ell)}^{C_\beta(\ell)} \mathcal{S}_{i_\beta(\ell)}^{c_\beta(\ell)} g_\ell^{(h_v)}] \right] \right\} \quad (3.51)
\end{aligned}$$

where: $d_{j_\beta(\ell)}(\mathbf{x}_\ell - \mathbf{x}'_\ell)$ is a suitable interpolation operators, dimensionally equivalent to $|\mathbf{x}_\ell - \mathbf{x}'_\ell|$ (and similarly $d_{j_\beta(v)}(\mathbf{x}_{v, \beta})$, is dimensionally equivalent to the distance operator among two distinct points in \mathbf{x}_v); the indices $b_\beta(v)$, $b_\beta(l)$, $q_\beta(f_\ell^1)$ and $q_\beta(f_\ell^2)$ are nonnegative integers ≤ 2 ; $j_\beta(v)$, $j_\beta(f_\ell^1)$, $j_\beta(f_\ell^2)$ and $j_\beta(\ell)$ can be either 1 or 2; $i_\beta(v)$ and $i_\beta(\ell)$ can be either 1 or 2; $I_\beta(v)$ and $I_\beta(l)$ can be either 0 or 1; $C_\beta(v)$, $c_\beta(v)$, $C_\beta(l)$ and $c_\beta(l)$ can be either 0, 1 and $\max\{C_\beta(v) + c_\beta(v), C_\beta(l) + c_\beta(l)\} \leq 1$; $G_\beta^{h_v, T_v}(\mathbf{t}_v)$ is obtained from $G^{h_v, T_v}(\mathbf{t}_v)$ by substituting the element $t_{i(f), i(f')} g^{(h_v)}(f, f')$ with $t_{i(f), i(f')} \hat{\partial}_{j_\beta(f)}^{q_\beta(f)} \hat{\partial}_{j_\beta(f')}^{q_\beta(f')} g^{(h_v)}(f, f')$.

It would be very difficult to give a precise description of the various contributions of the sum over B_T : however, we only need to know that the number of “zeros” $d_{j_\beta(\ell)}(\mathbf{x}_\ell - \mathbf{x}'_\ell)$, the number of “derivatives” $\hat{\partial}_{j_\beta(f)}$ and the scale of the propagators they act on are, by construction, such that all the potentially dangerous nodes v that are not e.p. (i.e. the nodes v that are not e.p. and with (P_v^ψ, P_v^A) equal either to $(2, 0)$, or $(4, 0)$, or to $(2, 1)$) gain a “scale jump” $2^{-(h_v - h_{v'})z(P_v)}$, where

$$z(P_v) = \begin{cases} 1 & \text{if } (|P_v^\psi|, |P_v^A|) = (4, 0) , \\ 2 & \text{if } (|P_v^\psi|, |P_v^A|) = (2, 0) , \\ 1 & \text{if } (|P_v^\psi|, |P_v^A|) = (2, 1) , \\ 0 & \text{otherwise} \end{cases} \quad (3.52)$$

which is enough to cure the apparent divergences present in Eq.(3.49). For more details, see e.g. [11, 25, 27], see also [28, Sec.2.2] for a recent pedagogical description of this point.

In conclusion, the kernels of the effective potential are bounded in a way completely analogous to Eq.(3.49), modulo the improved dimensional factors

induced by the action of the \mathcal{R} operators:

$$\begin{aligned} \frac{1}{|\Lambda|} \sum_{\beta \in B_T} \int d\mathbf{x}_{v_0} |W_{\tau, \mathbf{P}, T, \beta}(\mathbf{x}_{v_0})| &\leq C^{m+m} \left[\prod_{v \text{ normal e.p.}} (C|\lambda|)^{\max\{1, c|P_v^\psi|\}} \right] \\ &\cdot 2^{h(2-\frac{1}{2}|P_{v_0}^\psi| - |P_{v_0}^A|)} \left[\prod_{v \text{ not e.p.}} 2^{(h_v - h_{v'}) (2-\frac{1}{2}|P_v^\psi| - |P_v^A| - z(P_v))} \right], \end{aligned} \quad (3.53)$$

which is valid *provided that the running coupling constants stay close to their values on scale $h = N$* , for all scales between h and N . Under this assumption, Eq.(3.53) implies the analyticity of the kernels of $\mathcal{V}^{(h)}$ and $\mathcal{B}^{(h)}$ and the decay bounds Eq.(3.25).

An immediate corollary of the bound Eq.(3.53) is that contributions from trees $\tau \in \mathcal{T}_{N;n,m}^{(h)}$ with a vertex v on scale $h_v = k > h$ admit an improved bound with respect to Eq.(3.25), with an extra dimensional factor $2^{\theta(h-k)}$, $0 < \theta < 1$, which can be thought of as a dimensional gain with respect to the “basic” dimensional bound in Eq.(3.25). This improved bound is usually referred to as the *short memory* property (i.e., long trees are exponentially suppressed); it is due to the fact that the renormalized scaling dimensions $d_v = 2 - \frac{1}{2}|P_v^\psi| - |P_v^A| - z(P_v)$ in Eq.(3.53) are all negative, and can be obtained by taking a fraction of the factors $2^{(h_v - h_{v'})d_v}$ associated to the branches of the tree τ on the path connecting the vertex on scale k to the one on scale h .

Under the same assumptions, the beta function itself, $\beta_h^\#$, is analytic and dimensionally bounded by a constant independent of h . Moreover, the contributions to it from trees that have at least one node on scale $k > h$ is dimensionally bounded proportionally to $2^{\theta(h-k)}$, with $0 < \theta < 1$. It is remarkable that thanks to these bounds, the dynamical system induced by the beta function can be fully studied and shown to lead to a bounded flow of the running coupling constants, as discussed in the next section.

3.5 The flow of the running coupling constants

As announced above, the flow of the running coupling constants is controlled by the equations:

$$\begin{aligned} Z_{h-1} &= Z_h + \beta_h^Z, & \frac{\sigma_{h-1}}{\sigma_h} &= 1 + \beta_h^\sigma, \\ \nu_{h-1} &= 2\nu_h + \beta_h^\nu, & \frac{Z_{h-1}^{(1)}}{Z_h^{(1)}} &= 1 + \beta_h^{Z,1}, \end{aligned} \quad (3.54)$$

where $\beta_h^\# = \beta_h^\#((Z_h, \sigma_h, \nu_h, Z_h^{(1)}), \dots, (Z_N, \sigma_N, \nu_N, Z_N^{(1)}))$ is an analytic function of its argument, with an analyticity domain bounded by: $|Z_k - 1| +$

$|Z_k^{(1)} - 1| + |\nu_k| + \left| \frac{\sigma_k}{\sigma} - 1 \right| \leq \varepsilon_0$, for all $h \leq k \leq N$, where ε_0 is a suitable (small) positive constant.

Let us start by studying the flow of Z_h and ν_h . By construction, their beta functions, β_h^Z and β_h^ν , are independent of $Z_h^{(1)}$ and σ_h and, in particular, they are independent of the infrared cutoff scale h_σ , for all $h > h_m$. Therefore, the two coupled equations for Z_h and ν_h can be naturally studied for all $h \leq N$, without any infrared cutoff. Note also that both β_h^Z and β_h^ν can be expressed as sums over GN trees with at least two endpoints, and with at least one endpoint on scale $N + 2$, the reason being that the local part of the trees with only normal endpoints of scale $\leq N + 1$ is zero by the support properties of the single-scale propagators that enter the definition of $\beta_h^\#$. Therefore, by the short memory property, $|\beta_h^Z|, |\beta_h^\nu| \leq C_\theta |\lambda| 2^{\theta(h-N)}$.

In order to solve the two coupled equations for Z_h and ν_h we use a fixed point argument, following the same strategy as [27, Appendix A5]. Let $\mathfrak{M}_{N;K,\theta}$ be the space of sequences $\underline{\nu} = \{\nu_h\}_{h \leq N}$ such that $|\nu_h| \leq K |\lambda| 2^{-\theta(h-N)}$, $\forall h \leq N$; we shall think $\mathfrak{M}_{N;K,\theta}$ as a Banach space with norm $\|\cdot\|_\theta$, where $\|\underline{\nu}\|_\theta = \sup_{k \leq N} 2^{\theta(N-k)}$. Given $\underline{\nu} \in \mathfrak{M}_{N;K,\theta}$, we first solve the equation for Z_h , $Z_{h-1} = Z_h + \beta_h^Z$, which leads to a bounded and exponentially convergent flow. In fact, using the fact that $|\beta_h^Z| \leq C |\lambda| 2^{\theta(h-N)}$, it is straightforward to check inductively that, if $Z_N = 1$,

$$|Z_h(\underline{\nu}) - 1| \leq C |\lambda|, \quad |Z_h(\underline{\nu}) - Z_{-\infty}(\underline{\nu})| \leq C |\lambda| 2^{\theta h} \quad (3.55)$$

uniformly in $\underline{\nu}$ for $\underline{\nu} \in \mathfrak{M}_{N;K,\theta}$. Once that $Z_h = Z_h(\underline{\nu})$ is fixed as a function of $\underline{\nu}$, the beta function for ν_h can be thought of as function of $\underline{\nu}$ only, and we shall write $\beta_h^\nu(\underline{\nu})$. The goal is to fix ν_N in a smart way, so that the flow generated by $\beta_h^\nu(\underline{\nu})$ with initial datum ν_N generates a sequence in $\mathfrak{M}_{N;K,\theta}$. We note that the solution to the flow equation induced by the beta function with initial condition $\lim_{h \rightarrow -\infty} \nu_h = 0$ is a fixed point of the map $\mathbf{T} : \mathfrak{M}_{N;K,\theta} \rightarrow \mathfrak{M}_{N;K,\theta}$ defined by

$$(\mathbf{T}\underline{\nu})_h = - \sum_{j \leq h} 2^{j-h-1} \beta_j^\nu(\underline{\nu}). \quad (3.56)$$

The fact that, for K sufficiently large, \mathbf{T} is a map from $\mathfrak{M}_{N;K,\theta}$ to itself is a simple consequence of the bound $|\beta_h^\nu| \leq C |\lambda| 2^{\theta(h-N)}$. More interestingly, we can prove that \mathbf{T} is a contraction map on $\mathfrak{M}_{N;K,\theta}$. In fact, using the expansion in GN trees, the short memory property and the fact that the trees contributing to β_h^ν have at least one endpoint on scale $N + 2$, we find that if $\underline{\nu}, \underline{\nu}' \in \mathfrak{M}_{N;K,\theta}$, then

$$|\beta_h^\nu(\underline{\nu}) - \beta_h^\nu(\underline{\nu}')| \leq C |\lambda| \sum_{k \geq h} |\nu_k - \nu'_k| 2^{\theta(h-N)} \leq C' |\lambda| 2^{\theta(h-N)} \|\underline{\nu} - \underline{\nu}'\|_\theta, \quad (3.57)$$

which implies, if plugged back into Eq.(3.56), that

$$\|\mathbf{T}\underline{\nu} - \mathbf{T}\underline{\nu}'\|_\theta \leq c''|\lambda|\|\underline{\nu} - \underline{\nu}'\|_\theta, \quad (3.58)$$

i.e. \mathbf{T} is a contraction for $|\lambda|$ sufficiently small. Then the Banach fixed point theorem shows that \mathbf{T} has a unique fixed point $\underline{\nu}^*$ in $\mathfrak{M}_{N;K,\theta}$, such that

$$\nu_N = \nu_N^* = - \sum_{j \leq N} 2^{j-N-1} \beta_j^\nu(\underline{\nu}^*), \quad (3.59)$$

which is of order λ , as it should be. In fact, plugging Eq.(3.59) into Eq.(3.30) and using the relation of ν with the perturbed critical temperature, Eq.(2.60), shows that the distance between the interacting and the free critical temperatures is of order λ , as expected. A close examination of the proof also shows that the resulting ν is exactly independent of a (rather than being “just” bounded by $C|\lambda|$, independently of a). Similarly, the limiting value of $Z_h = Z_h(\underline{\nu}^*)$ as $h \rightarrow -\infty$, to be called simply $Z_{-\infty}(\lambda)$, is exactly independent of a .

Once that the flows of Z_h and ν_h have been controlled, the flows of σ_h and $Z_h^{(1)}$ can be studied easily, in the same fashion as the flow of Z_h at $\underline{\nu} \in \mathfrak{M}_{N;K,\theta}$ fixed. First of all, note that by construction both β_h^σ and $\beta_h^{Z,1}$ are independent of σ_h and, in particular, they are independent of the infrared cutoff scale h_σ , for all $h > h_\sigma$. Therefore, also the two equations for $\frac{\sigma_{h-1}}{\sigma_h}$ and $\frac{Z_{h-1}^{(1)}}{Z_h^{(1)}}$ can be naturally studied for all $h \leq N$, without any infrared cutoff. Moreover, β_h^σ , in complete analogy with the beta functions for Z_h and ν_h , can be expressed as sums over GN trees with at least two endpoints, and with at least one endpoint on scale $N+2$; similarly, $\beta_h^{Z,1}$ is a sum over GN trees with exactly one special endpoint (on an arbitrary scale) and at least one normal endpoint on scale $N+2$. Therefore, by the short memory property, $|\beta_h^\sigma|, |\beta_h^{Z,1}| \leq C_\theta |\lambda| 2^{\theta(h-N)}$, from which we get the analog of Eq.(3.55) (recall that $\sigma_N = \sigma$ and $Z_N^{(1)} = 1$):

$$|Z_h^{(1)} - 1| \leq C|\lambda|, \quad |Z_h^{(1)} - Z_{-\infty}^{(1)}| \leq C|\lambda|2^{\theta h}, \quad (3.60)$$

$$\left| \frac{\sigma_h}{\sigma} - 1 \right| \leq C|\lambda|, \quad \left| \frac{\sigma_h}{\sigma} - Z^*(\lambda) \right| \leq C|\lambda|2^{\theta h}, \quad (3.61)$$

where $Z_{-\infty}^{(1)}(\lambda)$ and $Z^*(\lambda)$ are two analytic functions of λ , analytically close to 1. As already observed for $Z_{-\infty}(\lambda)$, these two functions are independent of a .

4 The renormalized correlation functions

We are left with computing the renormalized m -points energy correlation functions and proving the main results stated in Section 1 and summarized in Theorems 1.1 and 1.2. We closely follow [7, Section 2.3]. Recall that the m -point correlation in the thermodynamic limit and at distinct points $\mathbf{x}_1, \dots, \mathbf{x}_m$, can be obtained by performing the functional derivative of the generating function $\Xi_{-, -}(\mathbf{A})$ constructed in the previous sections (here $\beta = \beta(a)$, fixed so that $2(t - t_c(0))/t = a\sigma + 4\pi\nu$, where $t = \tanh(\beta(a)J)$, ν is the temperature counterterm fixed as explained in the previous section and $\sigma = \sigma(a)$ is an a priori prescribed mass, such that $\lim_{a \rightarrow 0} \sigma(a) = m^* \in \mathbb{R}$):

$$\langle \varepsilon_{\mathbf{x}_1, j_1}; \dots; \varepsilon_{\mathbf{x}_m, j_m} \rangle_\beta^T = \lim_{L \rightarrow \infty} a^{-2m} \frac{\partial^m}{\partial A_{\mathbf{x}_1, j_1} \dots \partial A_{\mathbf{x}_m, j_m}} \log \Xi_{-, -}(\mathbf{A}) \Big|_{\mathbf{A}=\mathbf{0}}. \quad (4.1)$$

Performing this functional derivative is just a way of extracting from the generating function the kernel associated with the monomial $A_{\mathbf{x}_1, j_1} \dots A_{\mathbf{x}_m, j_m}$ in $\log \Xi_{-, -}(\mathbf{A}) = \sum_{h=h_\sigma-1}^N \bar{\mathcal{S}}_h(\mathbf{A})$, where $\bar{\mathcal{S}}_h(\mathbf{A})$ with $h < N$ is defined by Eq.(3.39) and $\bar{\mathcal{S}}_N(\mathbf{A}) := \mathcal{S}^{(N)}(\mathbf{A})$, see Eq.(3.3). The function $\bar{\mathcal{S}}_h(\mathbf{A})$ can be written in a way similar to Eq.(3.24):

$$\bar{\mathcal{S}}_h(\mathbf{A}) = \sum_{m \geq 1} \sum_{j_1, \dots, j_m} \int d\mathbf{x}_1 \dots d\mathbf{x}_m S_{m; \underline{j}}^{(h)}(\mathbf{x}_1, \dots, \mathbf{x}_m) \prod_{i=1}^m A_{\mathbf{x}_i, j_i}, \quad (4.2)$$

so that

$$\langle \varepsilon_{\mathbf{x}_1, j_1}; \dots; \varepsilon_{\mathbf{x}_m, j_m} \rangle_\beta^T = m! \sum_{h=h_\sigma-1}^N S_{m; \underline{j}}^{(h)}(\mathbf{x}_1, \dots, \mathbf{x}_m) \quad (4.3)$$

and the thermodynamic limit $L \rightarrow \infty$ is understood. Note the combinatorial factor $m!$ arising from the action of the derivatives w.r.t. $A_{\mathbf{x}_i, j_i}$ on $\bar{\mathcal{S}}_h(\mathbf{A})$. As explained in the previous sections, $S_{m; \underline{j}}^{(h)}(\mathbf{x}_1, \dots, \mathbf{x}_m)$ can be expressed by a sum over trees $\tau \in \mathcal{T}_{N; n, m_0}^{(h)}$ with $m_0 \leq m$ special endpoints and $n \geq 0$ normal end-points, and over a suitable set of field labels $\mathbf{P} \in \mathcal{P}_\tau$; $m_0 < m$ corresponds to the case where there is at least one normal endpoint v on scale $N + 2$ such that $P_v^A \neq \emptyset$. In formulae, we can write:

$$\begin{aligned} & \langle \varepsilon_{\mathbf{x}_1, j_1}; \dots; \varepsilon_{\mathbf{x}_m, j_m} \rangle_\beta^T = \\ & = m! \sum_{h=h_\sigma-1}^N \sum_{n \geq 0} \sum_{m_0=0}^m \sum_{\tau \in \mathcal{T}_{N; n, m_0}^{(h)}} \sum_{\substack{\mathbf{P} \in \mathcal{P}_\tau: \\ |P_{v_0}| = |P_{v_0}^A| = m}} S_{\tau, \mathbf{P}}(\mathbf{x}_1, j_1; \dots; \mathbf{x}_m, j_m), \end{aligned} \quad (4.4)$$

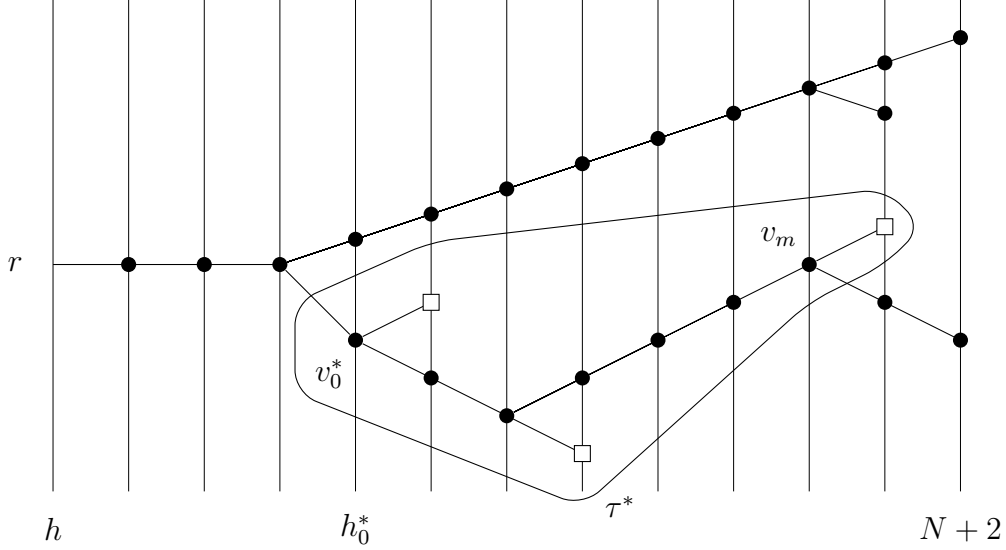

Figure 8: Example of a tree $\tau \in \mathcal{T}_{N;n,m_0}^{(h)}$ appearing in the expansion for the m points correlation function, with $n = 3$ and $m_0 = m = 3$. The subtree τ^* associated with τ and with a choice of \mathbf{P} such that $|P_{\bar{v}_0}| = |P_{\bar{v}_0}^A| = 3$ is highlighted.

where $S_{\tau,\mathbf{P}}(\mathbf{x}_1, j_1; \dots; \mathbf{x}_m, j_m)$ can be represented as in Eqs.(3.50)-(3.51), and bounded in a way similar to Eq.(3.53). Given $\tau \in \mathcal{T}_{N;n,m_0}^{(h)}$ and $\mathbf{P} \in \mathcal{P}_\tau$, let $E_{\tau,\mathbf{P}}^*$ be the set of endpoints v in τ such that $P_v^A \neq \emptyset$ (i.e. $E_{\tau,\mathbf{P}}^*$ contains all the special endpoints of τ plus the normal endpoints v on scale $N + 2$ such that $|P_v^A| \geq 1$); let us denote by τ^* the minimal subtree of τ connecting all the endpoints in $E_{\tau,\mathbf{P}}^*$. For each $v \in \tau$, if $m_v := |P_v^A|$, let s_v^* the number of vertices immediately following v with $m_v \geq 1$. Moreover, let $V_{nt}(\tau^*)$ be the set of vertices in τ^* with $s_v^* > 1$, which are the branching points of τ^* . For future reference, we also define v_0^* to be the leftmost vertex on τ^* and h_0^* its scale. See Fig.8.

Given these definitions and recalling that $d_v(P_v) = 2 - \frac{1}{2}|P_v^\psi| - |P_v^A| - z(P_v)$, we can write the bound for $S_{\tau,\mathbf{P}}(\mathbf{x}_1, j_1; \dots; \mathbf{x}_m, j_m)$ as

$$|S_{\tau,\mathbf{P}}(\mathbf{x}_1, j_1; \dots; \mathbf{x}_m, j_m)| \leq C^{m+m} 2^{h(2-m)} \left[\prod_{v \in V_{nt}(\tau^*)} 2^{2(s_v^*-1)h_v} e^{-c2^{h_v} \delta_v} \right]. \quad (4.5)$$

$$\cdot \left[\prod_{v \text{ not e.p.}} 2^{(h_v - h_{v'})d_v(P_v)} \right] \prod_{v \text{ e.p.}} \begin{cases} |\lambda|^{c|P_v^\psi|}, & \text{if } v \text{ is normal, } h_v = N + 2 \\ |\lambda|2^{\theta(h_v - N)}, & \text{if } v \text{ is normal, } h_v < N + 2 \\ 1, & \text{if } v \text{ is special} \end{cases}$$

This estimate is very similar to the bound Eq.(3.53) for the renormalized

kernels of the effective potential, the most important difference consisting in the product $\prod_{v \in V_{nt}(\tau^*)} 2^{2(s_v^*-1)h_v} e^{-c2^{h_v}\delta_v}$, where $\delta_v = \delta_v(\mathbf{x}_1, \dots, \mathbf{x}_m)$ is the tree distance of the set $\mathbf{x}_v^* := \cup_{f \in P_v^A} \{\mathbf{x}(f)\}$, i.e. the length of the shortest tree graph on \mathbb{R}^2 connecting the points of \mathbf{x}_v^* . In this product, the factors $2^{2(s_v^*-1)h_v}$ take into account the dimensional gain coming from the fact that we are *not* integrating over the space labels \mathbf{x}_i of the external fields (the gain is meant in comparison with Eq.(3.53) where, on the contrary, we integrated over all the field variables); moreover, the factors $e^{-c2^{h_v}\delta_v}$ come from the decaying factors $e^{-c2^{h_w}|\mathbf{x}(\ell)-\mathbf{x}'(\ell)|}$ associated with the propagators $g_\ell^{h_w}$ on the portion of spanning trees inside the cluster v , that is from the lines $\ell \in T_w$, $w \geq v$, see [7, Section 2.3] for a few more details about how to extract these factors starting from the bounds on the kernels of the effective potential. Moreover, note that in the second line we estimated the contribution from each endpoint of type ν by $(\text{const.})|\lambda|2^{\theta(h-N)}$, consistently with the bounds on ν_h derived in the previous section.

The bound Eq.(4.5) is one of the basic ingredients from which the main results of this paper follow. It makes apparent that all the terms with at least one endpoint on scale N or with one endpoint of type ν are strongly suppressed, in the sense that they are proportional to a short memory factor $2^{\theta(h-N)}$, which go to zero in the limit $N \rightarrow \infty$ (which corresponds to the scaling limit $a \rightarrow 0$): these are the terms leading to the correction term $R^{(a)}(\mathbf{x}_1, j_1; \dots; \mathbf{x}_m, j_m)$ in Theorem 1.2, as explained in more detail below. The dominant terms are those coming from trees $\tau \in \mathcal{T}_{N;0,m}^{(h)}$, which are of order 1 with respect to λ (because the size of the special endpoints is measured by $Z_h^{(1)}$, which is analytically close to 1), and whose dimensional bound does not vanish in the $N \rightarrow \infty$ limit. In the following, we show that: (1) the contributions to the m point function from trees $\tau \in \mathcal{T}_{N;0,m}^{(h)}$ can be written as the expression in the second line of Eq.(1.15) plus a remainder, bounded by the r.h.s. of Eq.(1.16); (2) the sum of the contributions from all the trees with $n \geq 1$ or $m_0 < m$ can be bounded by the r.h.s. of Eq.(1.16). This will conclude the proof of the main results stated in the introduction.

4.1 The dominant contributions

As discussed above, the dominant contribution to the m point energy correlation function come from trees $\tau \in \mathcal{T}_{N;0,m}^{(h)}$. Among these, we further distinguish the contributions from trees in $\mathcal{T}_{N;0,m}^{(h)}$ with at least one endpoint on scale $N+2$, which will be discussed at the end of this subsection, and

those with all the endpoints on scales $< N + 2$, which can be written as

$$K(\mathbf{x}_1, \dots, \mathbf{x}_m) := m! \sum_{h=h_\sigma-1}^N \sum_{\tau \in \mathcal{T}_{N;0,m}^*} \sum_{\substack{\mathbf{P} \in \mathcal{P}_\tau: \\ |P_{v_0}| = |P_{v_0^A}| = m}} S_{\tau, \mathbf{P}}(\mathbf{x}_1, j_1; \dots; \mathbf{x}_m, j_m), \quad (4.6)$$

where the $*$ on the sum indicates the constraint that all the endpoints are on scale $< N + 2$. By summing over trees, and by explicitly computing the tree values, $K(\mathbf{x}_1, \dots, \mathbf{x}_m)$ can be written in a way very similar to Eq.(1.8):

$$K(\mathbf{x}_1, \dots, \mathbf{x}_m) = -\frac{1}{2m} \left(\frac{i}{\pi}\right)^m \cdot \sum_{\pi \in \Pi_{\{1, \dots, m\}}} \sum_{\substack{\omega_1, \dots, \omega_m \\ h_1, \dots, h_m}} \left[\prod_{j=1}^m \omega_j Z_{\min\{h_j, h_{j+1}\}}^{(1)} g_{\omega_j, -\omega_{j+1}}^{(h_j)}(\mathbf{x}_{\pi(j)} - \mathbf{x}_{\pi(j+1)}) \right], \quad (4.7)$$

where the sum over the h_j 's runs over $h_\sigma \leq h_j \leq N$, with the convention that $g^{(h_\sigma)}$ is the propagator of $\psi^{(\leq h_\sigma)}$. Equation (4.7) differs from the corresponding expression for the free system in the renormalization of the special endpoints, $Z_{\min\{h_j, h_{j+1}\}}^{(1)}$, and in the propagators.

First of all, using Eq.(3.61), we can rewrite $Z_{\min\{h_j, h_{j+1}\}}^{(1)} = Z_{-\infty}^{(1)}(\lambda) + O(|\lambda|2^{2h})$. Similarly, using the explicit expression for $g^{(h)}$, Eq.(3.36), and the bounds Eqs.(3.55),(3.61), we rewrite (after having taken the thermodynamic limit $L \rightarrow \infty$) $g^{(h)}(\mathbf{x} - \mathbf{y}) = \mathbf{g}^{(h)}(\mathbf{x} - \mathbf{y}) + r_h(\mathbf{x} - \mathbf{y})$ where, for all $h_\sigma < h \leq N$,

$$\mathbf{g}^{(h)}(\mathbf{x}) = \frac{1}{Z_{-\infty}(\lambda)} \int_{[-\frac{\pi}{a}, \frac{\pi}{a}]^2} \frac{d\mathbf{k}}{2\pi} \frac{e^{-i\mathbf{k}\mathbf{x}} f_h(\mathbf{k})}{|D_a(\mathbf{k})|^2 + [Z^*(\lambda)\sigma]^2} \begin{pmatrix} D_a^+(\mathbf{k}) & iZ^*(\lambda)\sigma \\ -iZ^*(\lambda)\sigma & D_a^-(\mathbf{k}) \end{pmatrix}, \quad (4.8)$$

where r_h is a correction bounded as

$$\|r_h(\mathbf{x} - \mathbf{y})\| \leq C|\lambda|2^{\theta(h-N)}2^h e^{-c2^h|\mathbf{x}-\mathbf{y}|}. \quad (4.9)$$

If $h = h_\sigma$ we still write $g^{(h_\sigma)}(\mathbf{x}) = \mathbf{g}^{(h_\sigma)}(\mathbf{x}) + r_{h_\sigma}(\mathbf{x})$, with r_{h_σ} bounded as in Eq.(4.9) and $\mathbf{g}^{(h_\sigma)}(\mathbf{x})$ defined by an expression analogous to Eq.(4.8), with the only difference that $f_{h_\sigma}(\mathbf{k})$ is replaced by $\sum_{k \leq h_\sigma} f_k(\mathbf{k}) = e^{-2^{-2h_\sigma} \mathbf{k}^2}$.

Correspondingly, we rewrite Eq.(4.7) as the term obtained by replacing all the factors $Z_{\min\{h_i, h_{i+1}\}}^{(1)}$ by $Z_{-\infty}^{(1)}(\lambda)$ and all the propagators $g^{(h)}$ by $\mathbf{g}^{(h)}$ plus a remainder, which is the sum of all the terms involving at least one factor $Z_h^{(1)} - Z_{-\infty}^{(1)}$, or one factor $r_h(\mathbf{x})$:

$$K(\mathbf{x}_1, \dots, \mathbf{x}_m) = K^{(0)}(\mathbf{x}_1, \dots, \mathbf{x}_m) + K'(\mathbf{x}_1, \dots, \mathbf{x}_m) \quad (4.10)$$

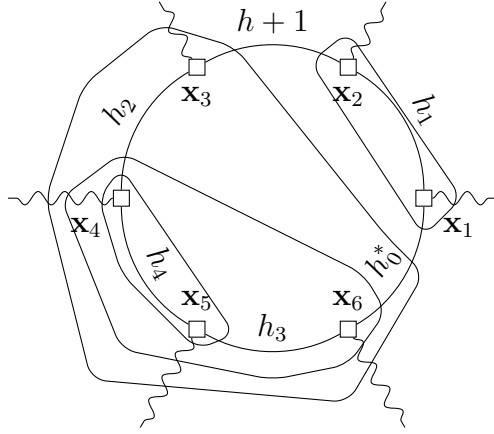

(a)

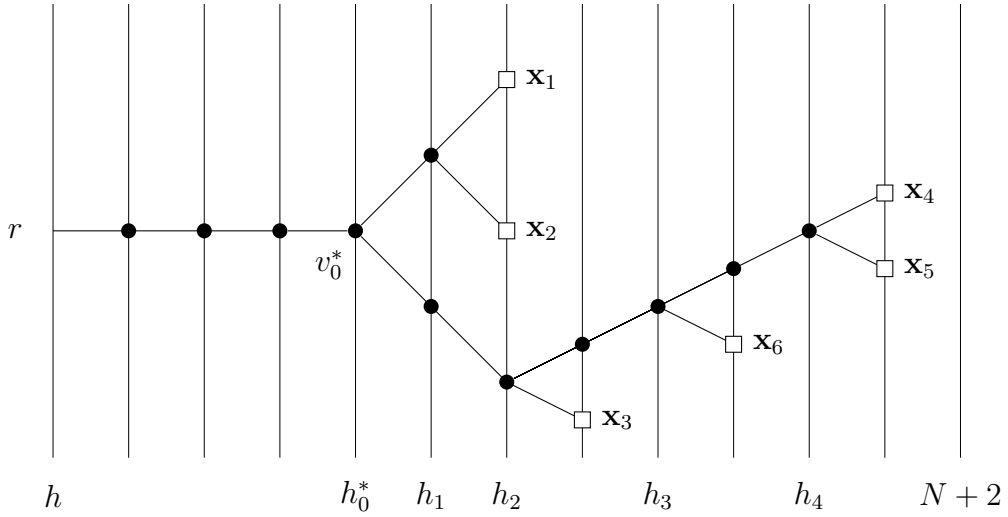

(b)

Figure 9: (a) A diagram representing one of the terms in the expression in Equation (4.6) for $K(\mathbf{x}_1, \dots, \mathbf{x}_6)$, with the scale labels of the propagators shown. The vertices are grouped into clusters according to scales of the connecting propagators. (b) A GN tree τ associated with this term; note that the branching points of the trees correspond to the clusters of vertices shown above, and that this tree is uniquely specified apart from the choice of which endpoint is identified with which coordinate.

where

$$K^{(0)}(\mathbf{x}_1, \dots, \mathbf{x}_m) = -\frac{1}{2m} \left(\frac{i}{\pi} \right)^m \cdot \sum_{\pi \in \Pi_{\{1, \dots, m\}}} \sum_{\substack{\omega_1, \dots, \omega_m \\ h_1, \dots, h_m}} \left[\prod_{j=1}^m \omega_j Z_{-\infty}^{(1)}(\lambda) \mathfrak{g}_{\omega_j, -\omega_{j+1}}^{(h_j)}(\mathbf{x}_{\pi(j)} - \mathbf{x}_{\pi(j+1)}) \right]. \quad (4.11)$$

Using the fact that $\sum_{h \leq N} f_h(\mathbf{k}) = 1$ we see that Eq.(4.11) is equal to the expression in the second line of Eq.(1.15), provided that $\bar{Z}(\lambda)$ in Eq.(1.14) is fixed to be $\bar{Z}(\lambda) = Z_{-\infty}^{(1)}(\lambda)/Z_{-\infty}(\lambda)$. Moreover, using the bounds Eqs.(3.37), (3.61), and (4.9) on $g^{(h)}$, $Z_h^{(1)} - Z_{-\infty}^{(1)}$, and r_h , respectively, the correction term $K'(\mathbf{x}_1, \dots, \mathbf{x}_m)$ can be bounded as:

$$|K'(\mathbf{x}_1, \dots, \mathbf{x}_m)| \leq C^m |\lambda| m! \sum_{h \leq N} 2^h \sum_{\tau \in \mathcal{T}_{N;0,m}^{(h)}} 2^{\theta(h_{v_m} - N)} \left[\prod_{v \in V_{nt}(\tau)} 2^{(s_v - 1)h_v} e^{-c2^{h_v} \delta_v} \right], \quad (4.12)$$

where the sum over trees has been re-introduced in order to properly keep track of the hierarchical scale structure induced by the choice of the scale labels of the propagators, as explained in the caption to Fig.9. Moreover v_m is the rightmost non trivial vertex of τ (e.g., $v_m = v_3$ in the example of Fig.9) and the set $V_{nt}(\tau)$ is the set of non trivial vertices of τ . Note that $\sum_{v \in V_{nt}(\tau)} 2^{h_v} \delta_v \geq 2^{h_0^*} D$, where $h_0^* := h_{v_0^*}$ and $D = D_{\underline{\mathbf{x}}}$ is the diameter of $\underline{\mathbf{x}} = \{\mathbf{x}_1, \dots, \mathbf{x}_m\}$. Therefore,

$$|K'(\mathbf{x}_1, \dots, \mathbf{x}_m)| \leq C^m |\lambda| m! \sum_{h \leq N} 2^h \sum_{\tau \in \mathcal{T}_{N;0,m}^{(h)}} e^{-c'2^{h_0^*} D} 2^{\theta(h_{v_m} - N)} \cdot \left[\prod_{v \in V_{nt}(\tau)} 2^{(s_v - 1)h_v} e^{-c'2^{h_v} \delta_v} \right], \quad (4.13)$$

where c' can be chosen to be half of the constant c in Eq.(4.12). We then separate the sum over τ into a sum over the various scale labels, and a sum over the remaining structure of the tree, which is indexed by an unlabeled tree t having the same endpoints as τ . We denote by $\mathfrak{T}_{0,m}$ the set of unlabeled trees with $n = 0$ normal endpoints and m special endpoints. Then introducing the variable $j = h - h_0^*$, ignoring all the constraints in the sum

over scales other than $h < h_0^*$,

$$|K'(\mathbf{x}_1, \dots, \mathbf{x}_m)| \leq C^m |\lambda| m! 2^{-\theta N} \sum_{t \in \mathfrak{X}_{0,m}} \sum_{j < 0} 2^j \sum_{h_0^* = -\infty}^{\infty} 2^{s_{v_0^*} h_0^*} e^{-c' 2^{h_0^*} (D + \delta_{v_0^*})} \cdot \sum_{h_{v_m} = -\infty}^{\infty} 2^{h_{v_m} (s_{v_m} - 1 + \theta)} e^{-c' 2^{h_{v_m}} \delta_{v_m}} \left[\prod_{\substack{v \in V_{nt}(\tau): \\ v \neq v_0^*, v_m}} \left(\sum_{h_v = -\infty}^{\infty} 2^{(s_v - 1) h_v} e^{-c' 2^{h_v} \delta_v} \right) \right].$$

Now, the sum over j gives a constant and we perform the other sums as follows. Letting $-h_{\delta_v}$ be the integer part of $\log_2 \delta_v$ so that $2^{-h_{\delta_v}} \leq \delta_v \leq 2^{(1-h_{\delta_v})}$, then for any $\alpha_v > 0$,

$$\sum_{h_v = -\infty}^{\infty} 2^{\alpha_v h_v} e^{-c' 2^{h_v} \delta_v} \leq 2^{\alpha_v} \delta_v^{-\alpha_v} \sum_{h_v = -\infty}^{\infty} 2^{\alpha_v (h_v - h_{\delta_v})} e^{-c' 2^{h_v - h_{\delta_v}} \delta_v} =: 2^{\alpha_v} \delta_v^{-\alpha_v} c_{\alpha_v}, \quad (4.14)$$

where

$$c_{\alpha} = \sum_{h = -\infty}^{\infty} 2^{\alpha h} e^{-c' 2^h} \leq \int_{-\infty}^{\infty} dx 2^{\alpha x} e^{-c' 2^x} + \max_y y^{\alpha} e^{-c' y} = (c')^{-\alpha} \left[\frac{\Gamma(\alpha)}{\log 2} + \left(\frac{\alpha}{e} \right)^{\alpha} \right] \quad (4.15)$$

In particular, if $\alpha \geq 1$, then $c_{\alpha} \leq C^{\alpha} \alpha^{\alpha}$ for a suitable $C > 0$. Therefore, letting $\delta = \delta_{\mathbf{x}} = \min_{1 \leq i < j \leq m} |\mathbf{x}_i - \mathbf{x}_j|$ and using also the fact that $\delta_v \geq (s_v - 1)\delta$,

$$|K'(\mathbf{x}_1, \dots, \mathbf{x}_m)| \leq (C')^m |\lambda| m! 2^{-\theta N} \sum_{t \in \mathfrak{X}_{0,m}} \left(\frac{s_{v_0^*}}{D + (s_{v_0^*} - 1)\delta} \right)^{s_{v_0^*}} \cdot \left(\frac{s_{v_m} - 1 + \theta}{(s_{v_m} - 1)\delta} \right)^{s_{v_m} - 1 + \theta} \left[\prod_{\substack{v \in V_{nt}(t): \\ v \neq v_0^*, v_m}} \left(\frac{s_v - 1}{(s_v - 1)\delta} \right)^{s_v - 1} \right].$$

Recall that $s_{v_0^*} \geq 2$: under this condition it is easy to check that

$$\left(\frac{s_{v_0^*}}{D + (s_{v_0^*} - 1)\delta} \right)^{s_{v_0^*}} \leq \frac{4\delta^{2-s_{v_0^*}}}{D^2}. \quad (4.16)$$

Finally, recalling that $\sum_{v \in V_{nt}(t)} (s_v - 1) = m - 1$ and noting that the sum over t simply gives the number of unlabeled trees with m endpoints (which is no more than 4^m), we get

$$|K'(\mathbf{x}_1, \dots, \mathbf{x}_m)| \leq (C'')^m |\lambda| m! \frac{1}{\delta^m} \left(\frac{a}{\delta} \right)^{\theta} \left(\frac{\delta}{D} \right)^2, \quad (4.17)$$

which is the desired estimate on the contributions to the m points function coming from the trees in $\mathcal{T}_{N;0,m}^{(h)}$.

The contributions to the m point function coming from trees $\tau \in \mathcal{T}_{N;0,m}^{(h)}$ with at least one special endpoint on scale $N+2$ can be bounded by a similar expression, with the difference that the factor $|\lambda|$ in the r.h.s. of Eq.(4.17) should be replaced by 1. We do not belabor the details of this computation, which is completely analogous to the one leading to Eq.(4.17). Let us just remark that these are the terms responsible of the fact that the r.h.s. of Eq.(1.16) is of order 1 w.r.t. λ . Of course, if desired, these contributions can be written explicitly (possibly modulo further corrections bounded as in Eq.(4.17)), by making use of the explicit expression of the source term $\bar{\mathcal{B}}(\psi, \chi, \mathbf{A})$, which is obtained from Eq.(2.45) by performing the linear change of variables Eq.(2.52), and of the explicit expression of the propagator of the χ field, Eq.(2.48). If we decided to isolate these terms from the correction $R^{(a)}$, then the remaining contributions would be bounded as in Eq.(4.17), as it follows from Eq.(4.17) itself and from the discussion in the following subsection.

4.2 The subdominant contributions

It remains to bound the trees with $n \geq 1$,

$$\begin{aligned} K''(\mathbf{x}_1, j_1; \cdots; \mathbf{x}_m, j_m) &:= \\ &:= m! \sum_{h=h_\sigma-1}^N \sum_{\substack{n \geq 1 \\ m_0 \leq m}} \sum_{\tau \in \mathcal{T}_{N;n,m_0}^{(h)}} \sum_{\substack{\mathbf{P} \in \mathcal{P}_\tau: \\ |P_{v_0}| = |P_{v_0}^A| = m}} S_{\tau, \mathbf{P}}(\mathbf{x}_1, j_1; \cdots; \mathbf{x}_m, j_m), \end{aligned} \quad (4.18)$$

where $S_{\tau, \mathbf{P}}(\mathbf{x}_1, j_1; \cdots; \mathbf{x}_m, j_m)$ can be estimated as in Eq.(4.5). For simplicity, we start by looking at the contributions to K'' coming from trees with $m = m_0$, to be called K''' :

$$\begin{aligned} K'''(\mathbf{x}_1, j_1; \cdots; \mathbf{x}_m, j_m) &:= \\ &:= m! \sum_{h=h_\sigma-1}^N \sum_{n \geq 1} \sum_{\tau \in \mathcal{T}_{N;n,m}^{(h)}} \sum_{\substack{\mathbf{P} \in \mathcal{P}_\tau: \\ |P_{v_0}| = |P_{v_0}^A| = m}} S_{\tau, \mathbf{P}}(\mathbf{x}_1, j_1; \cdots; \mathbf{x}_m, j_m), \end{aligned} \quad (4.19)$$

which is bounded as:

$$\begin{aligned}
|K'''(\mathbf{x}_1, j_1; \dots; \mathbf{x}_m, j_m)| &\leq m! \sum_{h=h_\sigma-1}^N \sum_{n \geq 1} \sum_{\tau \in \mathcal{T}_{N;n,m}^{(h)}} \sum_{\substack{\mathbf{P} \in \mathcal{P}_\tau: \\ |P_{v_0}| = |P_{v_0}^A| = m}} C^{m+m} \cdot \\
&\cdot 2^{h(2-m)} 2^{\theta(h_+-N)} \left[\prod_{v \in E_n(\tau)} (C|\lambda|)^{\max\{1, c|P_v^\psi|\}} \right] \cdot \quad (4.20) \\
&\cdot \left[\prod_{v \in V_{nt}(\tau^*)} 2^{2(s_v^*-1)h_v} e^{-c2^{h_v} \delta_v} \right] \left[\prod_{v \text{ not e.p.}} 2^{(h_v-h_{v'})d_v(P_v)} \right],
\end{aligned}$$

where h_+ is the scale of the rightmost normal endpoint and $E_n(\tau)$ is the set of normal endpoints of τ . We now want to reduce this expression to a simplified form as close as possible to Eq.(4.12) and then bound the simplified expression by a strategy similar to the one used in the previous subsection. The first step consists in “pruning” the tree τ of the branches that are not in τ^* . To this purpose, we make the following rearrangement. Let $\mathcal{T}_{N,h_0^*;m}^*$ be the set of labelled trees with m special endpoints, with no normal endpoints, and whose leftmost vertex v_0^* is nontrivial and on scale h_0^* . If $\tau^* \in \mathcal{T}_{N,h_0^*;m}^*$ and $h < h_0^*$, let $\mathcal{T}_N^{(h)}(\tau^*; n) \subseteq \mathcal{T}_{N;n,m}^{(h)}$ be the set of trees τ with root scale h and n normal endpoints such that τ^* is the subtree of τ connecting its special endpoints. Fix any $\theta \in (0, 1)$, $\varepsilon \in (0, 1/2)$ and $\phi \in (\max\{0, 1 - \theta - 3\varepsilon\}, 1 - \theta)$ and define, recalling that $m_v = |P_v^A|$,

$$\tilde{d}_v = \tilde{d}_v(P_v^A) := \begin{cases} 1 + \varepsilon - m_v, & m_v > 1 \\ -\theta - \phi, & m_v = 1 \\ 0, & m_v = 0 \end{cases} \cdot \quad (4.21)$$

It is easy to check that, if $|P_v^\psi| \geq 2$, and recalling that $d_v(P_v) = \min\{1 - \frac{1}{2}|P_v^\psi| - m_v, -1\}$, then

$$d_v - \tilde{d}_v = d_v(P_v) - \tilde{d}_v(P_v^A) \leq -\frac{1}{6}(1 - \theta - \phi)|P_v^\psi| - \theta\delta_{m_v,0} \cdot \quad (4.22)$$

It is convenient to rewrite Eq.(4.20) as

$$\begin{aligned}
|K'''(\mathbf{x}_1, j_1; \dots; \mathbf{x}_m, j_m)| &\leq C^m m! \sum_{h=h_\sigma-1}^N 2^{h(2-m)} \sum_{h < h_0^* \leq N+1} \sum_{\tau^* \in \mathcal{T}_{N,h_0^*;m}^*} \cdot \\
&\cdot 2^{(1+\varepsilon-m)(h_0^*-h)} \left[\prod_{v \in V_{nt}(\tau^*)} 2^{2(s_v^*-1)h_v} e^{-c2^{h_v} \delta_v} \right] \left[\prod_{v \in V(\tau^*)} 2^{\tilde{d}_v(h_v-h_{v'})} \right] \sum_{n \geq 1} C^n \cdot \\
&\cdot \sum_{\tau \in \mathcal{T}_N^{(h)}(\tau^*; n)} 2^{\theta(h_+-N)} \sum_{\substack{\mathbf{P} \in \mathcal{P}_\tau: \\ |P_{v_0}| = |P_{v_0}^A| = m}} \left[\prod_{v \in V(\tau)} 2^{(d_v - \tilde{d}_v)(h_v - h_{v'})} \right] \left[\prod_{v \in E_n(\tau)} (C|\lambda|)^{\max\{1, c|P_v^\psi|\}} \right],
\end{aligned}$$

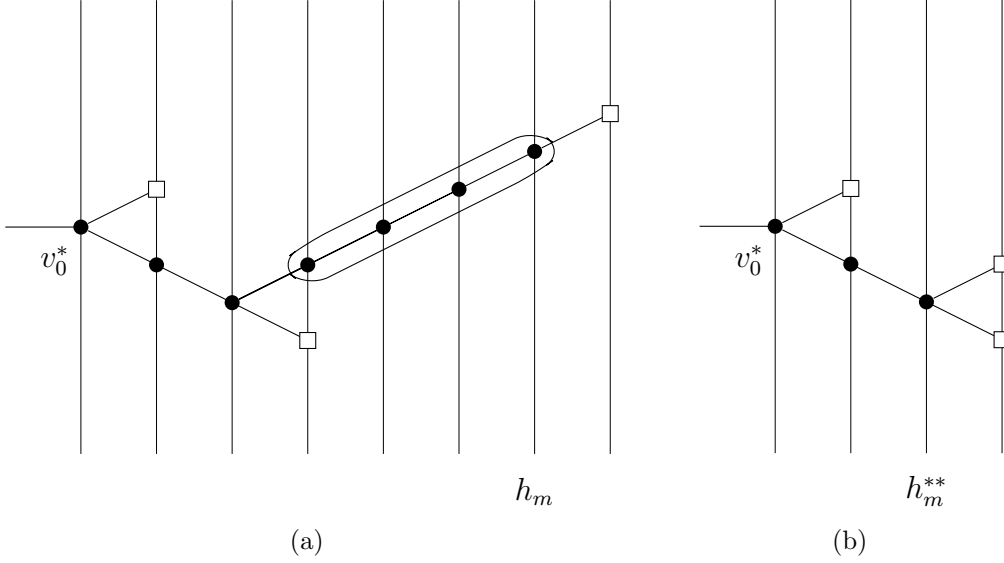

Figure 10: (a) The tree τ^* of Figure 8, with the set E highlighted. (b) The corresponding “contracted tree” τ^{**} .

where $V(\tau)$ is the set of vertices of τ that are not endpoints, and similarly for $V(\tau^*)$. Using Eq.(4.22) we can perform the sum over $\tau \in \mathcal{T}_N^{(h)}(\tau^*; n)$ and over $\mathbf{P} \in \mathcal{P}_\tau$, which gives

$$\begin{aligned} & \sum_{\tau \in \mathcal{T}_N^{(h)}(\tau^*; n)} 2^{\theta(h_+ - N)} \sum_{\substack{\mathbf{P} \in \mathcal{P}_\tau: \\ |P_{v_0}| = |P_{v_0}^A| = m}} \left[\prod_{v \in V(\tau)} 2^{(d_v - \tilde{d}_v)(h_v - h_{v'})} \right] \left[\prod_{v \in E_n(\tau)} (C|\lambda|)^{\max\{1, c|P_v^\psi|\}} \right] \\ & \leq C^{m+m} |\lambda|^n 2^{\theta(h_m - N)}, \end{aligned} \quad (4.23)$$

where h_m is the highest scale in τ^* . Plugging Eq.(4.23) back into the previous bound on K''' , and summing over $n \geq 1$ and over $h < h_0^*$ gives:

$$\begin{aligned} |K'''(\mathbf{x}_1, j_1; \dots; \mathbf{x}_m, j_m)| & \leq C^m |\lambda| m! \sum_{h_0^* \leq N+1} 2^{h_0^*(2-m)} \sum_{\tau^* \in \mathcal{T}_{N, h_0^*, m}^*} 2^{\theta(h_m - N)}. \\ & \cdot \left[\prod_{v \in V_{nt}(\tau^*)} 2^{2(s_v^* - 1)h_v} e^{-c2^{h_v} \delta_v} \right] \left[\prod_{v \in V(\tau^*)} 2^{\tilde{d}_v(h_v - h_{v'})} \right]. \end{aligned} \quad (4.24)$$

We now go from the sum over τ^* to an estimate in terms of a “contracted tree”, called τ^{**} , which is obtained from τ^* by removing the set E of vertices which precede exactly one special endpoint, see Figure 10. The sum over τ^* can then be expressed as the sum over τ^{**} (trees with only special endpoints, where each endpoint is attached to a branching point) and the sum over

compatible E (i.e. over the number of vertices inserted before each special endpoint); then Eq.(4.24) becomes (calling $\mathcal{T}_{N,h_0^*;m}^{**}$ the set of contracted trees τ^{**} with root on scale $h_0^* - 1$ and m endpoints)

$$\begin{aligned}
|K'''(\mathbf{x}_1, j_1; \dots; \mathbf{x}_m, j_m)| &\leq C^m |\lambda| m! \sum_{h_0^* \leq N+1} 2^{h_0^*(2-m)} \sum_{\tau^{**} \in \mathcal{T}_{N,h_0^*;m}^{**}} \cdot \\
&\cdot \left[\prod_{v \in V_{nt}(\tau^{**})} 2^{2(s_v^*-1)h_v} e^{-c2^{h_v} \delta_v} \right] \left[\prod_{v \in V(\tau^{**})} 2^{\tilde{d}_v(h_v - h_{v'})} \right] \cdot \\
&\cdot \sum_{E \sim \tau^{**}} \left[\prod_{v \in E} 2^{-(\theta+\phi)(h_v - h_{v'})} \right] 2^{\theta(h_m - N)}. \tag{4.25}
\end{aligned}$$

We use the factors $2^{-\phi(h_v - h_{v'})}$ to perform the summation over E , and use the remaining factor to replace h_m with the scale of the last branching point of τ^{**} , which we denote by h_m^{**} , see Fig.10:

$$\sum_{E \sim \tau^{**}} \left[\prod_{v \in E} 2^{-(\theta+\phi)(h_v - h_{v'})} \right] 2^{\theta(h_m - N)} \leq C^m 2^{\theta(h_m^{**} - N)}. \tag{4.26}$$

This leaves us with the estimate:

$$\begin{aligned}
|K'''(\mathbf{x}_1, j_1; \dots; \mathbf{x}_m, j_m)| &\leq C^m |\lambda| m! \sum_{h_0^* \leq N+1} 2^{h_0^*(2-m)} \sum_{\tau^{**} \in \mathcal{T}_{N,h_0^*;m}^{**}} \cdot \\
&\cdot \left[\prod_{v \in V_{nt}(\tau^{**})} 2^{2(s_v^*-1)h_v} e^{-c2^{h_v} \delta_v} \right] \left[\prod_{v \in V(\tau^{**})} 2^{\tilde{d}_v(h_v - h_{v'})} \right] 2^{\theta(h_m^{**} - N)}, \tag{4.27}
\end{aligned}$$

which is similar to Eq.(4.12). We would be tempted to proceed as we did after Eq.(4.12), that is by ignoring all the constraints in the sum over the scale labels and reduce the r.h.s. of Eq.(4.27) to a product of terms of the form $\sum_{h=-\infty}^{\infty} 2^{\alpha_v h_v} e^{-c2^{h_v} \delta_v}$, which is fine provided that $\alpha_v > 0$. However, here the exponent α_v associated with v_0^* is equal to $2s_{v_0^*}^* - m$, which in general is negative.

To rectify this we engage in a further rearrangement of the estimate, for which we introduce the following notation. Let $S_v^{*,2}$ denote, for $v \in V_{nt}(\tau^{**})$, the set of branching points following v but not following any vertex $w \in V_{nt}(\tau^{**})$ such that $w > v$ (see Figure 11), $S_v^{*,1}$ the set of endpoints immediately following v , and $S_v^* = S_v^{*,1} \cup S_v^{*,2}$; also let $s_v^* = |S_v^*|$ and similarly for $s_v^{*,1}$ and $s_v^{*,2}$. Since we have $\tilde{d}_v = 1 + \varepsilon - m_v$ for all non-endpoint vertices, we have the following estimate for each $v \in S_{v_0^*}^{*,2}$,

$$\prod_{v_0^* < w \leq v} 2^{\tilde{d}_w(h_w - h_{w'})} = 2^{(1+\varepsilon-m_v)(h_v - h_0^*)} \tag{4.28}$$

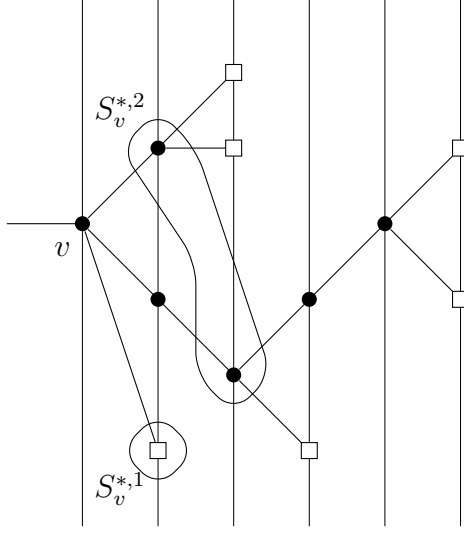

Figure 11: Example of the sets $S_v^{*,1}$ and $S_v^{*,2}$.

which since $\sum_{v \in S_{v_0^*}^{*,2}} (m_v - 1 - \varepsilon) = m - s_{v_0^*}^{*,1} - (1 + \varepsilon)s_{v_0^*}^{*,2} = m - (1 + \varepsilon)s_{v_0^*}^{*,2} + \varepsilon s_{v_0^*}^{*,1}$ implies

$$\begin{aligned} & 2^{(2s_{v_0^*}^{*,2} - m)h_0^*} \prod_{v \in S_{v_0^*}^{*,2}} \left(2^{2(s_v^* - 1)h_v} \prod_{v_0^* < w \leq v} 2^{\tilde{d}_w(h_w - h_{w'})} \right) = \\ & = 2^{[(1 - \varepsilon)s_{v_0^*}^{*,2} + \varepsilon s_{v_0^*}^{*,1}]h_0^*} \prod_{v \in S_{v_0^*}^{*,2}} 2^{(2s_v^* - m_v - 1 + \varepsilon)h_v} \end{aligned} \quad (4.29)$$

We now have a factor of $2^{(2s_v^* - m_v - 1 + \varepsilon)h_v}$ for each $v \in S_{v_0^*}^{*,2}$, and this can still produce a divergence. For these vertices we have

$$\begin{aligned} & 2^{(2s_v^* - m_v - 1 + \varepsilon)h_v} \prod_{u \in S_v^{*,2}} \left(2^{2(s_u^* - 1)h_u} \prod_{v < w \leq u} 2^{\tilde{d}_w(h_w - h_{w'})} \right) = \\ & = 2^{[(1 - \varepsilon)(s_v^* - 1) + \varepsilon s_v^{*,1}]h_v} \prod_{u \in S_v^{*,2}} 2^{(2s_u^* - m_u - 1 + \varepsilon)h_u} \end{aligned} \quad (4.30)$$

which we apply inductively to all branching vertices to obtain

$$|K'''(\mathbf{x}_1, j_1; \dots; \mathbf{x}_m, j_m)| \leq C^m |\lambda| m! 2^{-\theta N} \sum_{\substack{h_0^* \leq N+1 \\ \tau^{**} \in \mathcal{T}_{N, h_0^*; m}^{**}}} \left[\prod_{v \in V_{nt}(\tau^{**})} 2^{\alpha_v h_v} e^{-c2^{h_v} \delta_v} \right], \quad (4.31)$$

with

$$\alpha_v = \begin{cases} (1 - \varepsilon)s_v^* + \varepsilon s_v^{*,1}, & v = v_0^* \\ (1 - \varepsilon)(s_v^* - 1) + \varepsilon s_v^{*,1} + \theta, & v = v_m^{**} \\ (1 - \varepsilon)(s_v^* - 1) + \varepsilon s_v^{*,1}, & \text{otherwise} \end{cases} \quad (4.32)$$

Note that we then have $\alpha_v \geq 1/2$ and $\sum \alpha_v = m + \theta$. We can now sum this in the same way as explained after Eq.(4.12); noting that $\alpha_{v_0^*} \geq 2 - 2\varepsilon$, this gives

$$|K^m(\mathbf{x}_1, j_1; \dots; \mathbf{x}_m, j_m)| \leq C^m |\lambda|^m \frac{1}{\delta^m} \left(\frac{a}{\delta}\right)^\theta \left(\frac{\delta}{D}\right)^{2-2\varepsilon}, \quad (4.33)$$

which is valid for any $\theta \in (0, 1)$ and any $\varepsilon \in (0, 1/2)$, but that the ‘‘constants’’ depend on θ, ε , so we cannot take $\theta \rightarrow 1$ or $\varepsilon \rightarrow 0$.

The contributions to the m points energy correlations from trees with $n \geq 1$ normal endpoints and $m_0 < m$ special endpoints can be estimated via an analogous procedure and we are lead again to a bound like Eq.(4.33). We do not belabor the details of this computation here. Therefore, the proofs of Theorems 1.1 and 1.2 are complete.

Acknowledgements. We acknowledge financial support from the ERC Starting Grant CoMBoS-239694.

References

- [1] M. Aizenman. *Translation invariance and instability of phase co-existence in the two dimensional Ising system*. Communications in Mathematical Physics **73**, 83–94 (1980).
- [2] M. Bander and C. Itzykson. *Quantum-field-theory calculation of the two-dimensional Ising model correlation function* Phys. Rev. D **15**, 463–469 (1977).
- [3] G. Battle and P. Federbush. *A note on cluster expansions, tree graph identities, extra $1/n!$ factors!!!* Letters in Mathematical Physics **8**, 55–57 (1984).
- [4] R. Baxter. *Eight-vertex model in lattice statistics*. Physical Review Letters **26**, 832–833 (1971).
- [5] R. Baxter. *Exactly solved models in statistical mechanics*. London: Academic Press (1982).

- [6] A. Belavin, A. Polyakov, and A. Zamolodchikov. *Infinite conformal symmetry in two-dimensional quantum field theory*. Nuclear Physics B **241**, 333–380 (1984).
- [7] G. Benfatto, P. Falco, and V. Mastropietro. *Functional integral construction of the massive thirring model: verification of axioms and massless limit*. Communications in Mathematical Physics **273**, 67–118 (2007).
- [8] G. Benfatto, P. Falco, and V. Mastropietro. *Extended scaling relations for planar lattice models*. Communications in Mathematical Physics **292**, 569–605 (2009).
- [9] G. Benfatto and G. Gallavotti. *Perturbation theory of the fermi surface in a quantum liquid. a general quasiparticle formalism and one-dimensional systems*. Journal of Statistical Physics **59**, 541–664 (1990).
- [10] G. Benfatto, G. Gallavotti, A. Procacci, and B. Scoppola. *Beta function and schwinger functions for a many fermions system in one dimension. anomaly of the fermi surface*. Communications in Mathematical Physics **160**, 93–171 (1994).
- [11] G. Benfatto and V. Mastropietro. *Renormalization Group, Hidden Symmetries and Approximate Ward Identities in the XYZ Model*. Reviews in Mathematical Physics **13**, 1323–1435 (2001).
- [12] D. Brydges. *A short course on cluster expansions*. In *Phénomènes critiques, systèmes aléatoires, théories de jauge*, K. Osterwalder and R. Stora, eds., Les Houches summer school session 43, pages 129–183. North-Holland (1986).
- [13] D. Brydges and P. Federbush. *A new form of the Mayer expansion in classical statistical mechanics*. Journal of Mathematical Physics **19**, 2064 (1978).
- [14] D. Chelkak, C. Hongler, and K. Izyurov. *Conformal invariance of spin correlations in the planar Ising model* (2012). Arxiv preprint arXiv:1202.2838.
- [15] D. Chelkak and S. Smirnov. *Universality in the 2d Ising model and conformal invariance of fermionic observables*. Inventiones Mathematicae pages 1–66 (2009).

- [16] P. di Francesco, H. Saleur, and J. Zuber. *Critical Ising correlation functions in the plane and on the torus*. Nuclear Physics B **290**, 527–581 (1987).
- [17] V. Dotsenko and V. Dotsenko. *Critical behaviour of the phase transition in the 2d Ising model with impurities*. Advances in Physics **32**, 129–172 (1983).
- [18] J. Dubédat. *Dimers and analytic torsion I* (2011). Arxiv preprint arXiv:1110.2808.
- [19] J. Dubédat. *Exact bosonization of the Ising model* (2011). Arxiv preprint arXiv:1112.4399.
- [20] M. Fisher. *Quantum corrections to critical-point behavior*. Physical Review Letters **16**, 11–14 (1966).
- [21] G. Gallavotti. *Renormalization theory and ultraviolet stability for scalar fields via renormalization group methods*. Reviews of Modern Physics **57**, 471–562 (1985).
- [22] G. Gallavotti, F. Bonetto, and G. Gentile. *Aspects of ergodic, qualitative, and statistical theory of motion*. Springer Verlag (2004).
- [23] G. Gallavotti, A. Martin-Löf, and S. Miracle-Sole. *Some problems connected with the description of coexisting phases at low temperatures in the Ising model*. In *Statistical mechanics and mathematical problems*, A. Lenard, ed., pages 162–204. Springer (1973).
- [24] G. Gallavotti and F. Nicolò. *Renormalization theory in four-dimensional scalar fields, part I*. Communications in Mathematical Physics **100**, 545–590 (1985).
- [25] G. Gentile and V. Mastropietro. *Renormalization group for one-dimensional fermions. A review on mathematical results*. Physics Reports **352**, 273–438 (2001).
- [26] A. Giuliani. *The ground state construction of the two-dimensional hubbard model on the honeycomb lattice*. In *Quantum Theory from Small to Large Scales, Lecture Notes of the Les Houches Summer School, Volume 95*, J. Fröhlich, M. Salmhofer, V. Mastropietro, W. De Roeck, and L. F. Cugliandolo, eds. Oxford University Press (forthcoming).

- [27] A. Giuliani and V. Mastropietro. *Anomalous universality in the anisotropic Ashkin–Teller model*. Communications in Mathematical Physics **256**, 681–735 (2005).
- [28] A. Giuliani, V. Mastropietro, and M. Porta. *Anomalous behavior in an effective model of graphene with coulomb interactions*. Annales Henri Poincaré **11**, 1409–1452 (2010).
- [29] R. B. Griffiths. *Dependence of critical indices on a parameter*. Physical Review Letters **24**, 1479–1482 (1970).
- [30] Y. Higuchi. *On the absence of non traslationally invariant Gibbs states for the two dimensional Ising model*. In *Random Fields: Rigorous Results in Statistical Mechanics and Quantum Field Theory. Esztergom 1979*, J. Fritz, J. L. Lebowitz, and D. Szasz, eds. North Holland (1981).
- [31] C. A. Hurst and H. Green. *New solution of the Ising problem for a rectangular lattice*. Journal of Chemical Physics **33**, 1059 (1960).
- [32] C. Itzykson and J. Drouffe. *Statistical Field Theory: From Brownian Motion to Renormalization and Lattice Gauge Theory*. Cambridge Monographs on Mathematical Physics. Cambridge University Press (1991).
- [33] C. Itzykson and J. Drouffe. *Statistical Field Theory: Strong coupling, Monte Carlo methods, conformal field theory, and random systems*. Cambridge Monographs on Mathematical Physics. Cambridge University Press (1991).
- [34] L. P. Kadanoff. *Connections between the critical behavior of the planar model and that of the eight-vertex model*. Physical Review Letters **39**, 903–905 (1977).
- [35] B. Kaufman. *Crystal statistics. II. partition function evaluated by spinor analysis*. Physical Review **76**, 1232–1243 (1949).
- [36] B. Kaufman and L. Onsager. *Crystal statistics. III. short-range order in a binary Ising lattice*. Physical Review **76**, 1244–1252 (1949). And comment in *Supplemento Nuovo Cimento* **6**, 261 (1949).
- [37] R. Kenyon. *Dominos and the Gaussian free field*. Annals of probability **29**, 1128–1137 (2001).

- [38] G. Lawler, O. Schramm, and W. Werner. *Conformal invariance of planar loop-erased random walks and uniform spanning trees*. *Annals of Probability* **32**, 939–995 (2004).
- [39] A. Lesniewski. *Effective action for the Yukawa₂ quantum field theory*. *Communications in Mathematical Physics* **108**, 437–467 (1987).
- [40] E. H. Lieb. *Exact solution of the two-dimensional Slater KDP model of a ferroelectric*. *Physical Review Letters* **19**, 108–110 (1967).
- [41] V. Mastropietro. *Ising models with four spin interaction at criticality*. *Communications in Mathematical Physics* **244**, 595–642 (2004).
- [42] V. Mastropietro. *Non-Perturbative Renormalization*. World Scientific (2008).
- [43] B. McCoy and T. Wu. *The two-dimensional Ising model*. Harvard University Press (1973).
- [44] B. M. McCoy, J. H. H. Perk, and T. Wu. *Ising field theory: Quadratic difference equations for the n-point Green's functions on the lattice*. *Physical Review Letters* **46**, 757–760 (1981).
- [45] R. Minlos and Y. Sinai. *The phenomenon of separation of phases at low temperatures in certain lattice models of a gas I*. *Mathematics of the USSR-Sbornik* **2**, 335 (1967), and *Phenomenon of phase separation at low temperatures in certain lattice models of a gas II*. *Soviet Physics Doklady* **12**, 688 (1968).
- [46] L. Onsager. *Crystal statistics. I. a two-dimensional model with an order-disorder transition*. *Physical Review* **65**, 117–149 (1944).
- [47] H. Pinson and T. Spencer. *Universality and the two dimensional Ising model*. Unpublished preprint.
- [48] V. Riva and J. Cardy. *Holomorphic parafermions in the Potts model and stochastic Loewner evolution*. *Journal of Statistical Mechanics: Theory and Experiment* **2006**, P12001 (2006).
- [49] D. Ruelle. *Statistical Mechanics: Rigorous Results*. New York: W. A. Benjamin (1969).

- [50] S. Samuel. *The use of anticommuting variable integrals in statistical mechanics. I. The computation of partition functions.* Journal of Mathematical Physics **21**, 2806 (1980).
- [51] B. Schroer and T. Truong. *The order/disorder quantum field operators associated with the two-dimensional Ising model in the continuum limit.* Nuclear Physics B **144**, 80–122 (1978).
- [52] T. D. Schultz, D. C. Mattis, and E. H. Lieb. *Two-dimensional Ising model as a soluble problem of many fermions.* Reviews of Modern Physics **36**, 856–871 (1964).
- [53] S. Smirnov. *Conformal invariance in random cluster models. I. Holomorphic fermions in the Ising model.* Annals of Mathematics **72**, 1435–1467 (2010).
- [54] T. Spencer. *A mathematical approach to universality in two dimensions.* Physica A Statistical Mechanics and its Applications **279**, 250–259 (2000).
- [55] S. Tomonaga. *Remarks on Bloch’s method of sound waves applied to many-fermion problems.* Progress of Theoretical Physics **5**, 544–569 (1950).
- [56] K. G. Wilson and J. Kogut. *The renormalization group and the ϵ expansion.* Physics Reports **12**, 75–199 (1974).
- [57] C. N. Yang. *The spontaneous magnetization of a two-dimensional Ising model.* Physical Review **85**, 808–816 (1952).
- [58] J. B. Zuber and C. Itzykson. *Quantum field theory and the two-dimensional Ising model.* Phys. Rev. D **15**, 2875–2884 (1977).